

# Triple Maintenance Manual

## Section 6 - Frame & Running Gear Service

<b>Handlebar</b>	<b>Rear Swingarm</b>	<b>Disc Brake Service</b>
<b>Removing</b>	<b>Lubrication</b>	<b>Removing Pads</b>
<b>Installing</b>	<b>Inspecting for Worn Bushings</b>	<b>Replacing Pads</b>
<b>Twistgrip</b>	<b>Removing</b>	<b>Servicing the Caliper</b>
<b>Steering Stem</b>	<b>Inspecting Alignment</b>	<b>Servicing the Master Cylinder</b>
<b>Checking Bearing Adjustment</b>	<b>Inspecting and Replacing Bushings</b>	<b>Cleaning and Inspecting</b>
<b>Adjusting Bearings</b>	<b>Installing</b>	<b>Assembling</b>
<b>Removing</b>	<b>Adjusting Chain Tension</b>	<b>Bleeding the Hydraulic System</b>
<b>Cleaning and Inspecting</b>	<b>Lubricating the Drive Chain</b>	<b>Wheel Hubs and Bearings</b>
<b>Replacing Damaged Races</b>	<b>Brake System</b>	<b>Removing</b>
<b>Installing</b>	<b>Drum Brake Operation</b>	<b>Cleaning and Inspecting</b>
<b>Front Fork</b>	<b>Drum Brake Service</b>	<b>Assembling</b>
<b>Steel Slider Forks</b>	<b>Assembling</b>	<b>Installing the Wheels</b>
<b>Disassembling</b>	<b>Equalizing Twin-Cam Brake</b>	<b>Tires and Tubes</b>
<b>Inspecting</b>	<b>Installing</b>	<b>Inflation Pressure</b>
<b>Assembling</b>	<b>Centering the Brake Panel</b>	<b>Removing the Tire</b>
<b>Aluminum Slider Forks</b>	<b>Adjusting the Front Brake</b>	<b>Inspecting</b>
<b>Disassembling</b>	<b>Adjusting Brake Pedal Position</b>	<b>Wheel Balancing</b>
<b>Inspecting</b>	<b>Adjusting Rear Brake</b>	<b>Swingarm Specifications</b>
<b>Assembling</b>	<b>Adjusting Rear Brake Light Switch</b>	<b>Tire Specifications</b>
<b>Rear Shock Absorbers</b>	<b>Disc Brake Operation</b>	<b>Fork Specifications</b>
<b>Removing</b>		<b>Drum Brake Specifications</b>
<b>Inspecting</b>		<b>Disc Brake Specifications</b>
<b>Installing</b>		

Index

## Chapter 6



Because the rider's safety is so dependent on the integrity and reliability of the motorcycle frame and running gear, regular maintenance and inspection are required. When repair is undertaken, care and attention to detail must be exercised to insure that the motorcycle is roadworthy after servicing. Before test riding the machine, make sure you have installed all cotter pins, spring clips, and locknuts on all critical running gear components: frontend rear-axle nuts, rear brake panel torque link bolts and pins, brake linkages, and chain adjusters. Inspect the front and rear brakes for proper adjustment and safe operation. Check the handlebar clamp bolts for tightness. **CAUTION: Loose handlebar clamps will permit the handlebar to rotate forward during hard braking, resulting in a serious loss of control.**

The most frequently performed service on the running gear is everyday maintenance such as adjusting the chain and brakes and inspecting tire pressure. Preventive maintenance, which is required at longer intervals, has to do with periodically inspecting wheel alignment, tightening spokes, adjusting the steering head bearings, changing the front fork oil, inspecting the brakes, and tightening bolts and nuts.

If the motorcycle is involved in an accident, carefully inspect the frame for cracks and misalignment. In the event of structural damage, replacement of the frame is necessary. **CAUTION: Reliable frame repair is an extremely difficult job. Welding, heating, or straightening the damaged section can result in a weakened frame structure.**

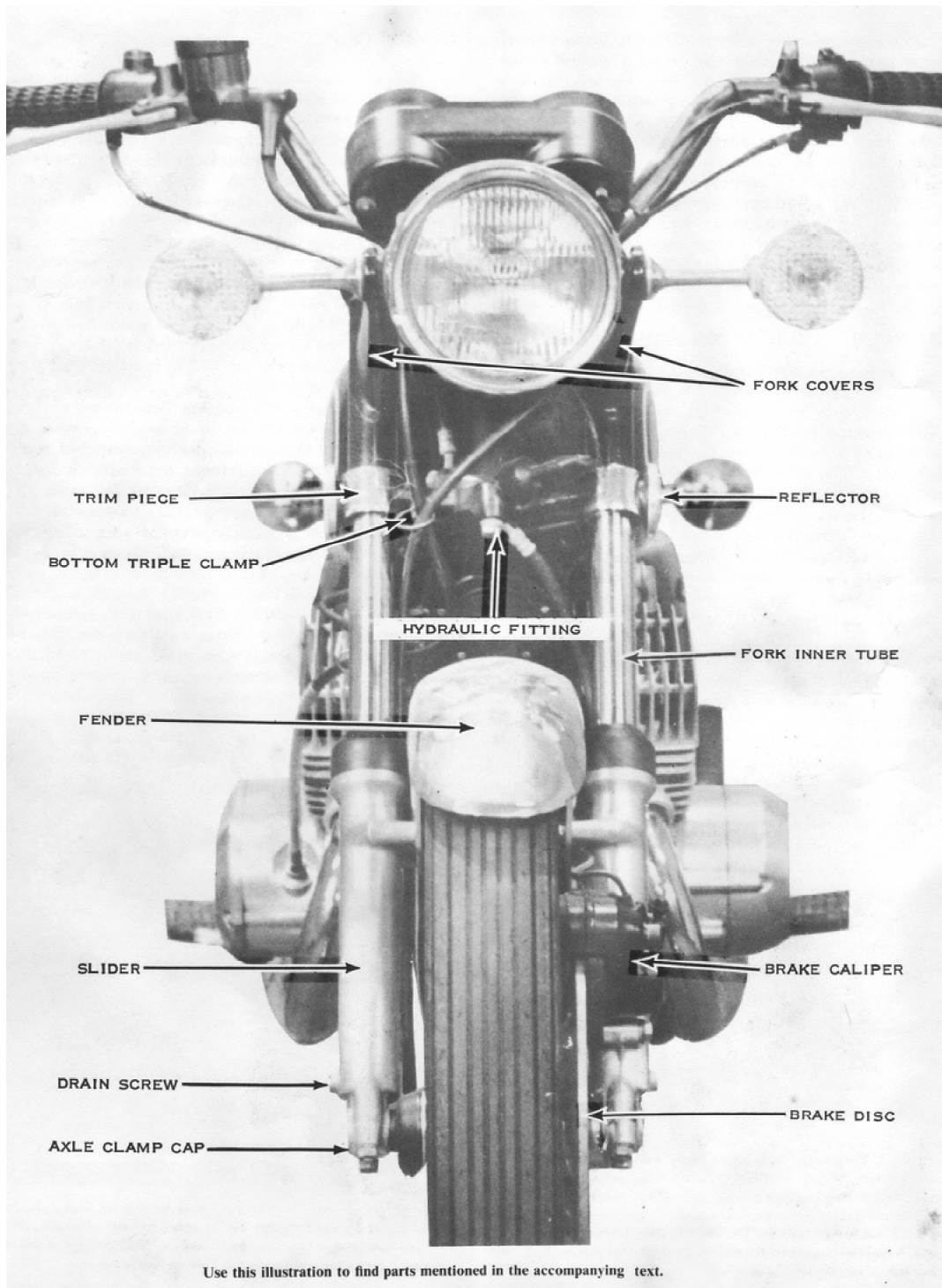

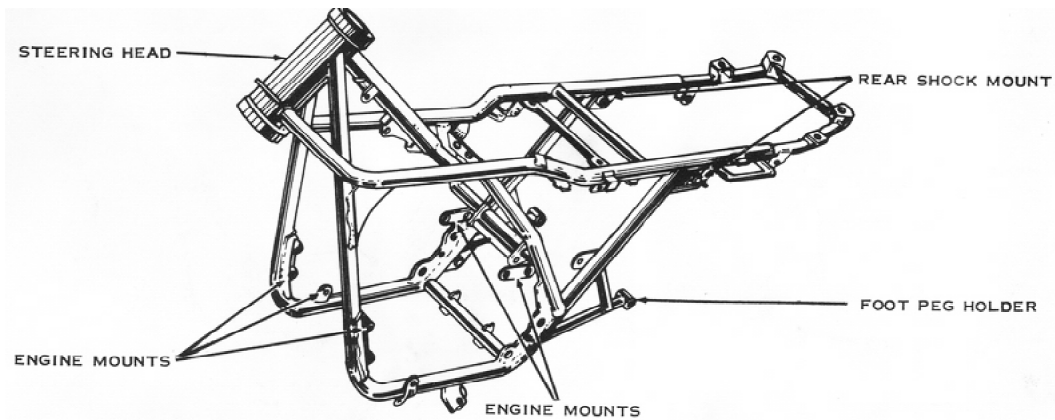

This is the tube type of frame used on S-series models. All others are very similar.

## ◆HANDLEBAR

The only service for the handlebar is straightening or replacing it. If the handlebar is bent more than 2", it must be replaced. **CAUTION: A straightened handlebar may be so weak that it will break while riding.** To straighten a slightly bent handlebar, slip a 4' length of pipe over the handgrip. Wedge the front wheel between two rigid uprights, then force the handlebar back to its original shape.

## ◆REMOVING

To disconnect the front brake and clutch cables, turn the adjuster all the way in until the slots in the locknut and the adjuster line up with the slot in the lever bracket. Compress the hand lever, then pull on the cable sheath while releasing the lever. Swing the cable out through the slot and drop the cable nipple out of the socket in the hand lever.

Remove the screws holding the left-hand switch case together, and then lift the case halves from the handlebar. Remove the bolts that clamp the master cylinder to the handlebar, and cradle the master cylinder on top of the headlight on a rag.

Loosen the screws holding the right-hand switch case together, but do not remove them. While holding the handlebar up so it can't fall on the fuel tank, remove the four handlebar clamp bolts and the clamp caps. Now move the handlebar to the left to allow the right-hand switch case and the twistgrip to slide off the end of the handlebar.

Unscrew the mirrors from the clutch and front brake lever brackets. To remove the clutch and front brake lever brackets, loosen the bolts, and then slide them off each end of the handlebar. Of course the left handgrip must be removed before the clutch lever bracket. If it will not slide off, pry it away from the handlebar with a screwdriver, and drip gasoline or solvent between the grip and handlebar to lubricate it so that it can slide off easily. If you intend to replace the left handgrip, the old one should be slit lengthwise with a sharp knife to remove it.

Before installing a new handlebar, make sure it has the same outside diameter as the stock handlebar, 7/8". **CAUTION: Never install a handlebar of a nonstandard diameter, because loss of control can result from the handlebar slipping in the clamps during hard acceleration or braking.** *NOTE: If a custom handlebar with more height or width is installed, you will have to install longer control cables and hydraulic lines at the same time. Check your local and state ordinances for maximum and minimum handlebar height and width.*

Slip the clutch and front brake lever brackets onto the ends of the handlebar. Lubricate the right end of the handlebar with grease. Holding the handlebar over the tank, slip the right switch case and twistgrip onto the right-hand end of the handlebar. Hold the handlebar in position and install the handlebar clamp caps and bolts. Rotate the handlebar to your preference and tighten the clamp bolts to 12-15 ft-lbs. of torque.

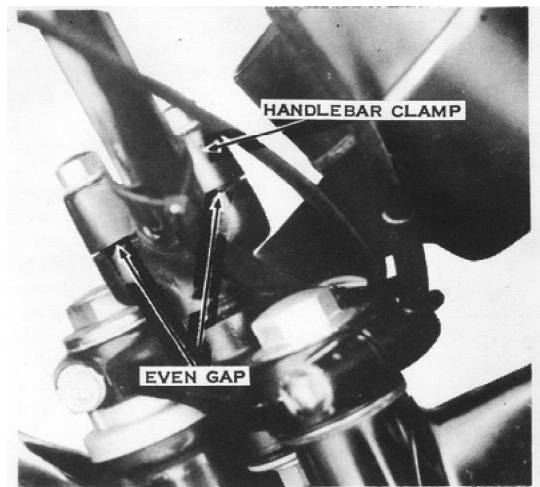

Handlebar clamps must have even, equal spaces at the front and rear when they are mounted. Torque the bolts to 12 ft-lbs. on S-series models and 15ft-lbs. on H-series models.

Assemble the halves of the left-hand switch case on the left end of the handlebar. Lubricate the left-hand grip with gasoline or solvent, and then slip it onto the left end of the handlebar. Push the left-hand switch case against the left-hand grip. then tighten its screws securely. Push the twistgrip as far onto the right end of the handlebar as possible without the twistgrip rubber touching the end of the handlebar, and then tighten the screws so that the switches are in a convenient position.

Hold the master cylinder in position on the handlebar and install the clamp cap and bolts. The lug on the side of the clamp cap is designed to locate the master cylinder the proper distance from the twistgrip housing. Rotate the clutch and front brake lever brackets (and/or the master cylinder) to your preference, then tighten the clamp bolts to 4.5 ft-lbs. of torque. Install the mirrors.

TWISTGRIP

To remove the twistgrip, first remove the case screws. Separate the case halves and allow them to hang by their attached wiring and cables. Turn the twistgrip so that the cable nipple can be removed from the twistgrip reel. The cold-start cable on 1972 models and earlier is removed in the same manner.

If the switches or wiring need to be replaced, the entire twistgrip housing must be replaced. Remove the headlight from its shell by taking out the two screws from the bottom of the chrome ring or out of the lower rear portion of the shell. Unplug the headlight and put it in a safe place. **CAUTION: If you allow the headlight to hang by its wiring, it could easily pull loose and break.** These are special headlights, available only from Kawasaki dealers, and are much more expensive than automotive-type headlights. Unplug the right-hand switch case wiring inside the headlight shell. This includes a single black wire to the engine stop switch on 1973 and later H1 models, and 1974 and later H2 models. To remove the lower case half from the throttle

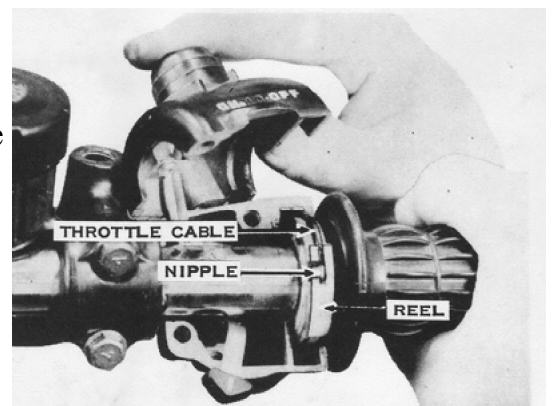

Slide the twistgrip onto the handlebar, then push the cable ferrule into the hole in the twistgrip reel. Turn the twistgrip in the direction shown to take up cable slack, position the upper throttle housing over the reel, then install the screws.

cable (and cold-start cable on some models), loosen the cable elbow locknut, then unscrew the elbow out of the case half. The elbow is part of the cable housing and stays with the cable.

If you wish to replace the twistgrip rubber on 1973 and later models, you must replace the entire reel-and-grip assembly. The plastic reel is molded into the rubber during manufacture. If you plan to use a custom grip rubber, the old rubber can be removed from the plastic reel by slicing it lengthwise with a sharp knife. **CAUTION: Be sure to use an adhesive designed for use with plastic to secure the new grip rubber to the reel. If the grip rubber pulled off during hard acceleration, you would lose control.** Earlier models use a metal reel that is a tight slip-fit into the grip rubber. *NOTE: A twistgrip rubber has a larger inside diameter than a left-hand grip rubber, to accommodate the reel.*

To assemble the twistgrip onto the handlebar, start by pushing the wiring through the hole in the back of the headlight shell and securing all the items you disconnected during removal. There should be one plastic multiprong connector on most units and one additional black wire on 1973 and later H1 models and 1974 and later H2 models. Models from 1969 through 1972 have no wiring to the right-hand case, but they do have a cold-start cable in addition to the throttle cable. Insert the ends of the control cables through the threaded holes in the lower case half. The throttle cable goes into the larger diameter end of the case. Screw the cable elbows about halfway into the case. Lubricate the end of the handlebar with grease and slip the cold-start lever-and-reel assembly onto it. Insert the cold-start and throttle cables' nipples into the sockets on the lever-and-reel assembly. Push the end of the cold-start lever through the slot in the lower case half, then fit the lower case half onto the handlebars from below so that the throttle cable reel fits into the larger diameter section of the case. Fit the upper case half and insert the screws. **CAUTION: On models with wiring to this case, be sure the wires are not pinched during assembly.** Rotate the case to position the switches, etc., conveniently, and then tighten the screws securely. **CAUTION: Remember that the outer end of the grip rubber must not drag on the end of the handlebar. This could stick the throttle open.**

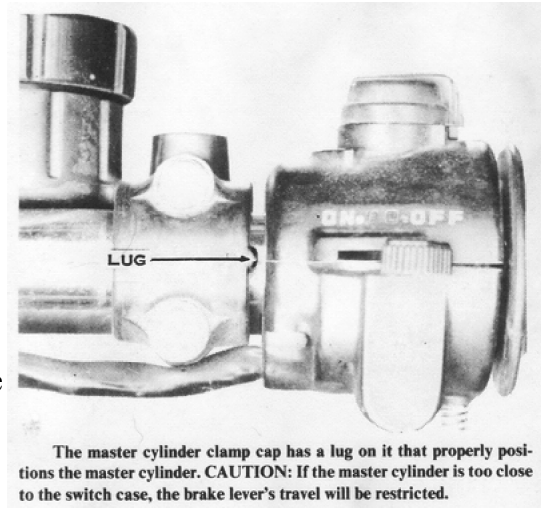

The master cylinder clamp cap has a lug on it that properly positions the master cylinder. **CAUTION: If the master cylinder is too close to the switch case, the brake lever's travel will be restricted.**

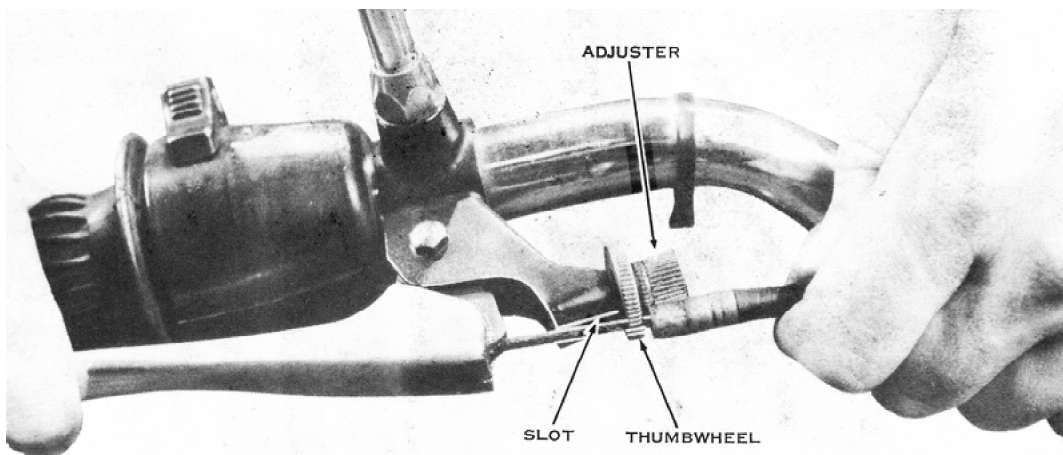

To install the clutch cable, push the nipple into the lever socket. Turn the adjusting nut into the bracket, then back it out to align the slots in the adjusting nut, locknut, and lever bracket. Pull on the cable sheath and hook the sheath end fitting on the locknut rim. Squeeze the lever against the handlebar and simultaneously release the lever and swing the cable through the slots and into the adjusting nut socket.

## STEERING STEM

The steering stem is the kingpin of the motorcycle's frame, because it handles the steering and front suspension forces. Both ends of the stem are supported in the frame by uncaged ball bearings, to reduce steering friction. The bottom triple clamp is welded to the bottom of the stem, whereas the top triple clamp is secured to the top of the stem with a large nut or bolt. The steering fork lock is an integral part of the bottom triple clamp or the steering head section of the frame. On some models there is an adjustable friction-type steering damper mounted below the bottom triple clamp to stop steering oscillations caused by high-speed riding on uneven surfaces. It has an adjustment knob at the top of the stem. Other models use a hydraulic-type telescopic damper between the bottom triple clamp and the frame for the same reason. This type is adjustable by a knob on the rear end of the damper unit. Some models have both types of steering dampers installed at once.

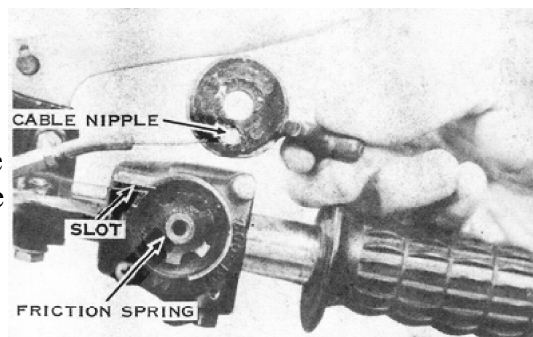

Install the cold-start cable by inserting it into the drum and hooking the nipple into the bottom of the reel. Wrap the cable around the lever reel before pushing the lever into the drum. Take care to prevent jamming the cable between the lever and the drum base or the lever will bind after the bolt is tightened. *NOTE: The friction washer can be left out of the drum base so that the lever must be held open for a rich mixture; this helps prevent flooding the engine.*

## CHECKING THE BEARING ADJUSTMENT

To check the steering bearings for excessive clearance, apply the front brake and push forward on the handlebar. If the top triple clamp moves away from the fuel tank or the steering stem clicks, the steering bearings are too loose. To check the bearings for an excessively tight adjustment, park the motorcycle on the center stand and sit on the seat so that the front wheel is clear of the ground. The handlebar should fall easily from lock to lock. Tight bearings are evidenced by binding or catching. *NOTE: Intermittent binding of the steering bearings indicates corrosion or cracking of the steel balls, which must be replaced.*

## ADJUSTING THE BEARINGS

It is best to remove the fuel tank to gain access to the steering bearing adjustment nut. Loosen the center clamp bolt on the top triple clamp (not found on H1, H1A, and H1C models) and the top triple clamp stem nut or bolt. Tighten the bearing adjuster nut with a hook spanner until the steering is stiff, and then back it off just enough to eliminate any bearing drag. Hold the adjuster nut in this position while tightening the stem nut or bolt. Tighten the center clamp bolt on the top triple clamp.

## REMOVING

Support the motorcycle on the center stand, then take off the fuel tank and handlebar. Remove the headlight from its shell and take off the shell from the forks. *NOTE: On some models, the shell is supported by the turn signals.* Remove the speedometer cable from the front hub, and then disconnect the brake cable. Loosen the axle clamps or axle nut, then remove the front wheel. Remove the front fender by taking out the bolts holding it to the fork sliders. Remove the steering damper(s), if used. Loosen all three top triple clamp bolts, then remove the stem nut or bolt and the fork tube top bolts (on H1, H1A, and H1C only). Loosen the bottom triple clamp bolt on the right fork leg and the turn signal clamp bolt, then slide the fork leg out. Store the fork leg in an upright position, and reinsert the top bolt to keep out dust. Pull the fork cover, turn signal clamp, and any spacers, washers, or chrome covers out from between the top and bottom triple clamps. On disc-brake models, remove the two bolts holding the disc brake caliper assembly to the left fork slider, and then remove the hydraulic fitting from the bottom triple clamp. Remove the entire hydraulic system from the motorcycle in a unit to eliminate the need for bleeding the system during assembly. *NOTE: On some models, the hydraulic fitting is built into the bottom triple clamp, and on these models the hydraulic lines must be removed. They will need to have the hydraulic system bled during assembly.* Now loosen the bottom triple clamp bolt on the left side and slide out the left fork leg. Pull the fork cover, turn signal clamp, and any spacers, washers, or chrome covers out from between the top and bottom triple clamps. Remove the speedometer and tachometer cables from the bottom of the instruments, then lift the top triple clamp, complete with instruments, off the top of the stem. While holding the bottom triple clamp up, remove the steering bearing adjuster nut. Hold the top bearing race down and slowly lower the steering stem/bottom triple clamp assembly out of the steering head so as not to lose any ball bearings. Carefully lift the top bearing race, then remove the balls from both ends of the stem.

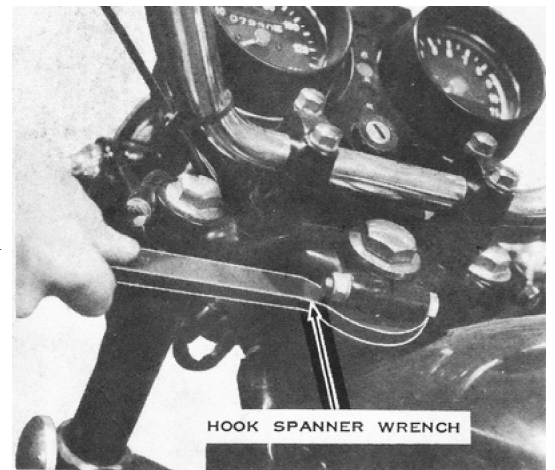

To adjust the steering bearing, loosen the locknut with a spanner wrench, then turn the adjuster nut as shown to take up bearing play. Tighten the nut until the steering is stiff, back it off just enough to eliminate any drag, and then tighten the locknut.



## ◆CLEANING AND INSPECTING

Wash the parts in solvent and blow them off with compressed air. Wipe old grease and dirt out of the bearing races inside the steering stem head on the frame with a cloth soaked in solvent. Inspect the steel balls and all four bearing races for signs of rust, wear, chips, or cracks. Replace all four of these parts if any component is damaged. Hold a straightedge alongside the stem to check for bending. Lay a straightedge across the two flanges on the bottom triple clamp to make sure they are in line. Check the bores in the bottom triple clamp for signs of fretting or uneven contact with the fork tubes. Inspect the welded joint between the steering stem and the bottom triple clamp for signs of failure. Check the underside of the top triple clamp for hairline cracks. *NOTE. These parts are not affected by wear as much as being susceptible to damage from the momentary stresses resulting from a collision or accident.* **CAUTION: Replace any part with questionable structure integrity. A weakened triple clamp can separate during hard braking or cornering, and damaged steering bearings can bind or lock up without warning.**

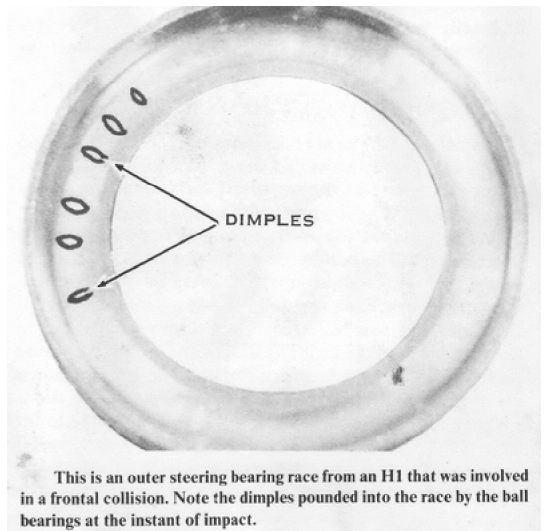

## ◆REPLACING DAMAGED BEARING RACES

To remove the two bearing races from the steering head, use a long rod and a hammer to punch them out. Remove the race from the bottom of the steering stem by inserting a chisel between the race and the bottom triple clamp. Tap the chisel lightly all around the race to lift it free.

Install new bearing races with a hammer and a bearing driver. The bearing driver must push against the outside edges of the steering head races and against the inside edge of the bottom race on the steering stem. **CAUTION: Make sure the bearing races are fully seated after installation, or the steering adjustment can loosen while riding.**

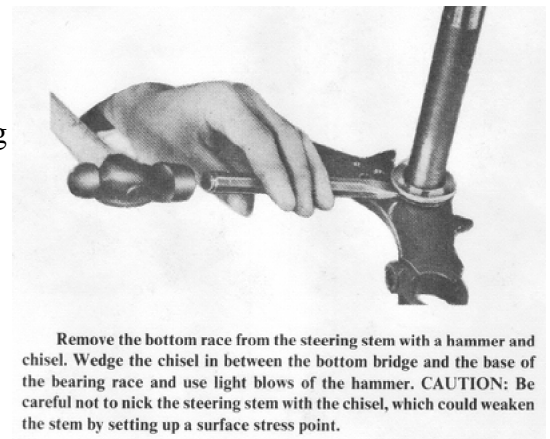

## INSTALLING

Use plenty of thick, waterproof grease on the steel balls and bearing races. Install nineteen 1/4" balls in the top steering head bearing race, and nineteen 1/4" balls in the bottom steering stem race. **CAUTION: Do not use more than nineteen balls in either end of the bearing even though there seems to be room for one more, or the steering bearings will bind.** Set the topmost race on top of the bearings in the steering head to hold them in place while carefully lifting the steering stem into position. Put the dust cover over the top of the stem, then thread on the adjuster nut finger tight.

Set the top triple clamp with instruments on the steering stem, but do not push it all the way down. Insert the left-hand fork cover with the turn signal clamp (and any spacers, washers, or chrome covers that were removed) between the top and bottom triple clamps. Slip the left-hand fork leg into the triple clamp assembly and snug the bottom triple clamp bolt. Fasten the hydraulic fitting to the bottom triple clamp (or connect the hydraulic lines). Route the hydraulic line to the master cylinder so it will go over the top triple clamp. Fasten the caliper unit to the left fork slider and tighten the bolts to 20 ft-lbs. of torque. Position the right-hand fork cover and turn signal clamp (with any spacers, washers, or chrome covers that were removed) between the top and bottom triple clamps. Slip the right fork leg into the triple clamp assembly and snug the bottom triple clamp bolt. Install the fork tube top bolts (if they were removed) and tighten them. Push the top triple clamp down, then install the top stem nut or bolt. Tighten it securely. Make sure the tops of the fork tubes are flush with the top triple clamp, and tighten all three top triple clamp bolts. Now tighten the lower triple clamp bolts. Install the headlight and handlebars, and then connect the wiring. Install the steering damper, if used. Be sure to bleed the front brake hydraulic system as described later in this chapter.

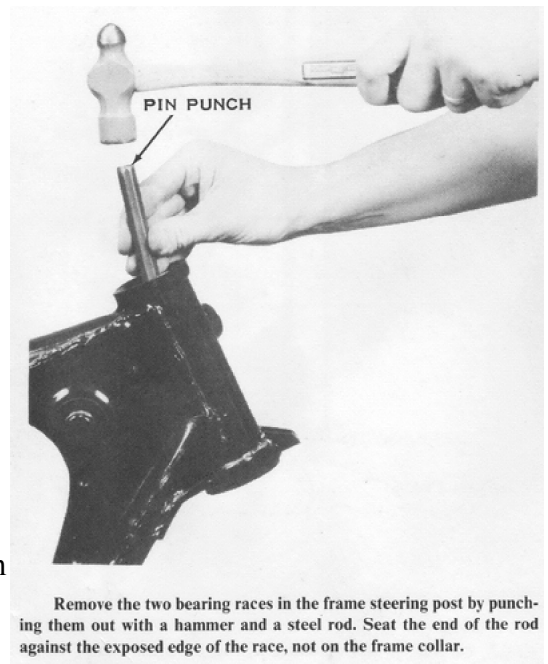

## FRONT FORK

The front fork supports the front of the frame and cushions it from road bumps. Two different types of internally sprung telescopic forks are used. They are differentiated by the fork slider material, steel or aluminum.

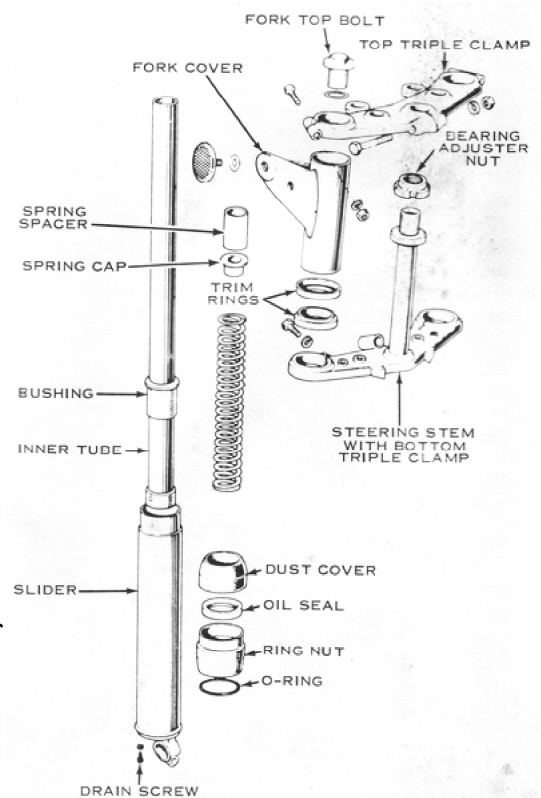

An exploded drawing of the steel slider type forks used on S1A, S1B, S1C, S2, H1, H1A, and H1C models.

## STEEL SLIDER FORKS

Steel slider forks are used on the H1, H1A, H1C, and S1 models. These also have a drum-type front brake. The springs that support the weight of the vehicle are inside the fork tubes. The top ends of the springs are held down by the bolts on the top ends of the fork tubes (on the top triple clamp). The bottom ends of the springs are pushed upward by stiff, rodlike spring holders in the centers of the steel sliders. Each spring holder is an integral part of the slider and reaches from the bottom of the slider to within an inch of the top. The inner tube is chrome plated on its outer surface to make it resist the up-and-down rubbing motion of the slider. The top end of the slider has a metal bushing inside it that bears against the inner tube. The bottom end of the inner tube has a metal bushing on it that bears against the inside of the slider. Thus the two tubes (the inner tube and the slider) can telescope up and down on each other, with the spring to hold them extended.

To damp the natural bouncing action of the spring, a hydraulic damping mechanism is incorporated in the inner tube. The fork leg is full of oil which is forced through small metering holes and one-way valves in the inner tube to control the bounce of the spring.

## DISASSEMBLING

To disassemble the fork legs, first remove the from wheel and fender. To do this, disconnect the front brake and speedometer cables. Remove the axle cotter pin. then unscrew the axle nut. Loosen the axle clamp boll and pull out the axle. The wheel will drop straight down out of the forks. Remove the four bolts holding the fender brackets to the fork sliders.

Loosen the top triple clamp bolts (S1 only), and then remove the fork top bolts. **CAUTION: These bolts hold the fork springs under compression. Hold them down while removing them to prevent their threads being stripped.** Use a strap wrench to remove the ring nut on the top of the slider. Slip the slider down and off the inner tube. The fork spring will come out with the slider. Pour the oil out of the slider. Loosen the lower triple clamp bolt, then pull the inner tube out of the triple clamps. If you remove only one side of the forks at a time, the headlight assembly will not have to be removed.

## INSPECTING

Clean the inside of the slider with solvent. The bore should be smooth, with no scratches or worn spots. Feel the lip of the seal with your finger to check for cuts or roughness, which indicates that replacement is necessary. Check the piston and valve on the lower end of the inner tube. The valve plate should be free to

move up and down slightly. The outer surface of the piston should be smooth, with no scratches or worn spots. Pull the slide bushing off the inner tube to check its inside surface which should also be smooth, with no scratches or worn spots. Roll the inner tube on a flat surface to check for bends or flat spots. Inspect the surface of the inner tube carefully for scratches, nicks, pits, or peeling chrome, which will ruin the fork seal.

Measure the free length of the fork spring to check for weakening because of age and use. Compare this measurement to the specification at the end of this chapter. If it is less than the service limit, both fork springs must be replaced to balance the spring effect in the forks.

## ASSEMBLING

If you have decided to replace the fork oil seal, remove the circlip that holds the seal into the ring nut. Pry the seal out with an appropriate tool such as a rounded screwdriver. Carefully drive the new seal into place with a hammer, using the old seal as a tool. The old seal will protect the new one from being damaged by the hammer. Be sure the new seal is seated securely, then replace the washer and circlip. Pull the O-ring out of the bottom end of the ring nut, and then push a new one into place. *NOTE: A little oil or grease on the O-ring will make this job much easier.*

Put the spring holder rod, large end first, into the slider. Oil the piston end of the inner tube lightly with SAE 10W fork oil, then slip it into the slider so that it fits over the end of the spring holder. Slide the metal bushing down over the inner tube and seat it firmly to the shoulder in the slider. Slip the ring nut on the same way and screw it securely onto the slider. Push the rubber dust seal down over the inner tube and onto the ring nut.

Replace the fork leg in the triple clamps, and then tighten the bolts securely. Drop the spring into the inner tube, then pour in the amount of SAE 10W fork oil recommended in the specifications at the end of this chapter. Push the fork top bolt down to prevent its threads from being stripped while screwing it into place.

## ALUMINUM SLIDER FORKS

Aluminum slider forks are used on all models from 1972 on, except the S1 models, which use steel slider forks. The springs that support the weight of the motor cycle are inside the upper (or inner) fork tube. The upper fork tube is a close fit inside the aluminum slider. The top ends of the springs are held down by bolts screwed into the upper ends of the inner fork tubes. The lower ends rest on "fork cylinders" inside the sliders. The fork cylinders look like long rods reaching from the bottom of the slider up into the inside of the inner tube. On the upper end of the fork cylinder is a piston that fits the inside of the inner fork tube. The fork spring rests on top of the piston. As the front of the motorcycle, rises and falls, the inner tube telescopes in and out of the fork slider. The spring holds them extended.

To resist the natural tendency of a spring to bounce, the bottom of the inner tube has a valved piston that fits closely around the fork cylinder. Oil inside the fork leg is forced back and forth through the valved piston, inside the fork cylinder, and through the fork cylinder piston and into the spring chamber to control the spring bounce. Because these parts are bathed in oil, they seldom wear out. If the oil leaks out of the fork past the seal between the inner tube and the slider, the loss of damping action and the oil mess will signal the problem before any damage can occur.

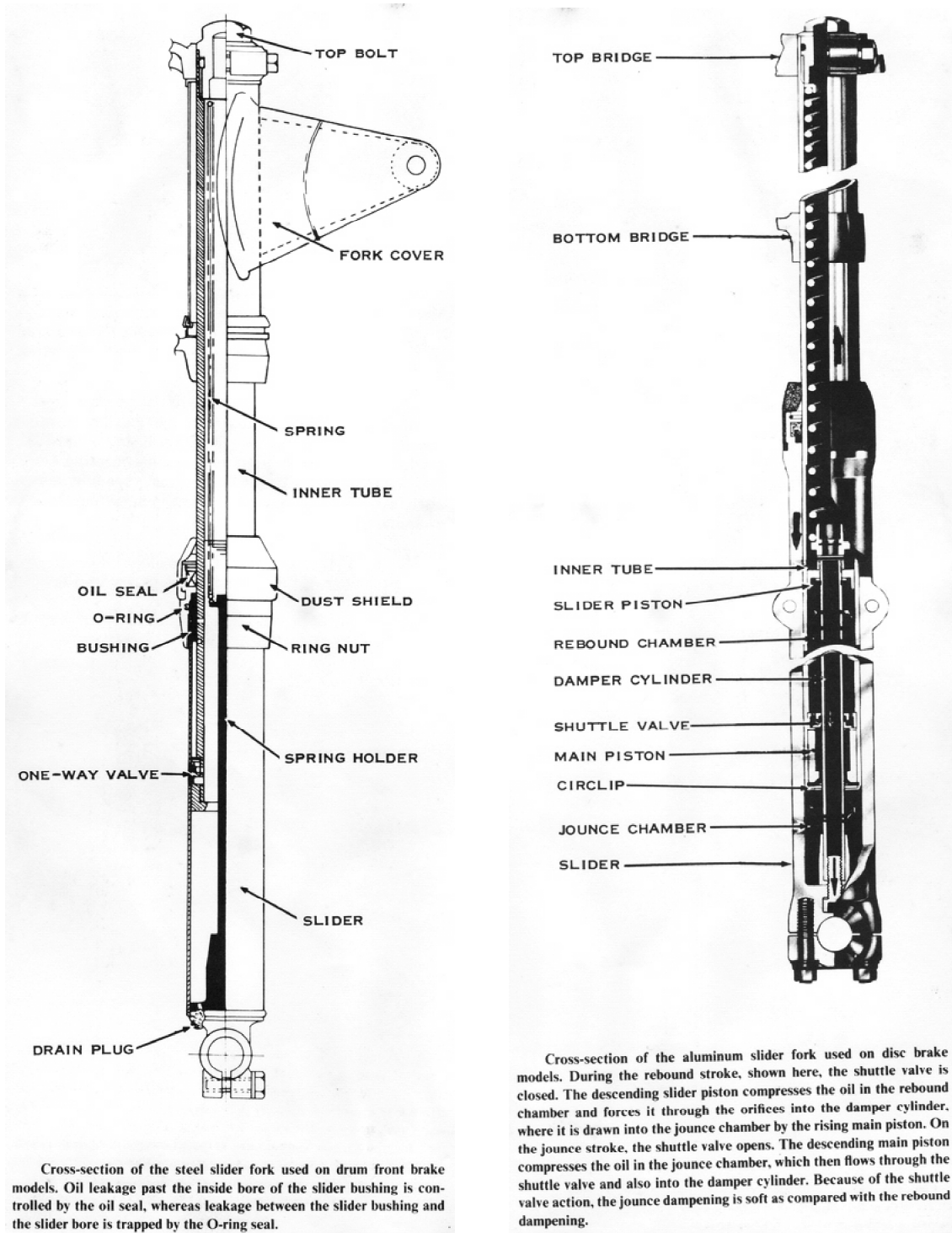

## DISASSEMBLING

The forks are easily disassembled if the fork seals need to be replaced. To disassemble the fork legs, start by removing the front wheel. Take out the speedometer cable, loosen the axle clamp cap nuts, remove the axle clamp caps, and then drop the front wheel straight down and out of the forks. Remove the four bolts holding the fender brackets to the fork slider and the two bolts holding the caliper to the left-hand slider. Fashion a wire hook to hang the caliper unit from the handlebar. If the caliper is not removed or disassembled, the system will not need to be bled during assembly. Remove the small screw at the bottom of each slider to drain the oil.

1) Loosen the top triple clamp bolts, then remove the top fork bolt as shown. Use a hooked piece of wire to pull out the fork spring and any spacers or seats. Keep them in order so you can install them correctly.



2) Use an Allen wrench to remove the bolt from the bottom of the slider. **CAUTION: Do not lose the washer on this bolt.** Remove the slider by pulling it straight down and off the end of the inner tube.

**Note:** It is sometimes easier to remove this bolt if fork is fully assembled and a quick snap is used to break the bolt free. Use of an air gun may be required unless a special tool is used to hold the nut within the fork leg.



3) Use a pair of circlip pliers to remove the circlip from inside the end of the inner tube. The fork cylinder will now slide out of the inner tube. **CAUTION: Do not remove the loose parts from the fork cylinder. If any of them need replacement, the entire assembly must be purchased.** If there is no conical aluminum compression stop on the bottom end of the fork cylinder, it is inside the fork cylinder. Dump it out and clean the slider in solvent.

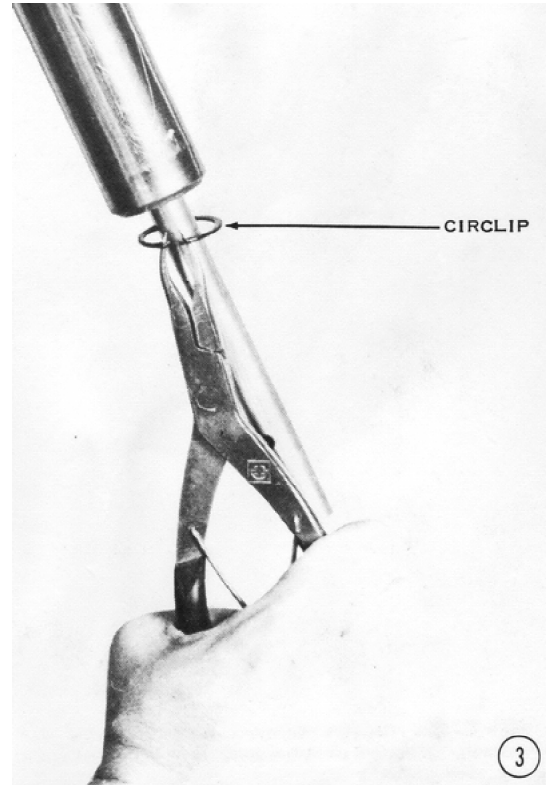

## INSPECTING

Feel the lip of the seal inside the slider with your finger to check for cuts or roughness, which indicates replacement is necessary. Look at the inner surface of the slider with a flashlight. It should be smooth and shiny, with no scratches or worn places; otherwise it must be replaced. Inspect the piston on the end, of the fork cylinder. If it is scratched or shows signs of wear, the entire fork cylinder must be replaced. The replacement cylinder will include all of the damping mechanism parts. Wear or failure of these parts is unheard of. Replace them only if they are obviously broken (compare them with the parts from the other fork leg).

Loosen the lower triple clamp bolt, then remove the inner tube. Roll the tube on a flat surface to check for bends or flattened spots, which would cause the forks to seize. Inspect the outer surface of the tube for scratches, pits, peeling chrome, or worn spots which would ruin the new fork seal.

The fork springs gradually weaken with use and age. Measure their free length and compare it to the specification at the end of this chapter. If one spring is shorter than the service limit, replace both springs to balance the front spring force.

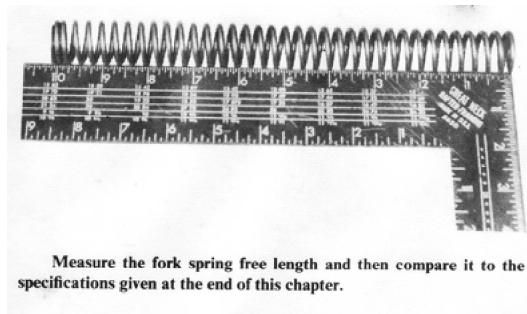

## ASSEMBLING

4) To replace the fork seal, first pull off the rubber dust cover, then remove the retaining ring and washer inside the end of the slider. **CAUTION: This ring is under tension. Do not let it get away.**

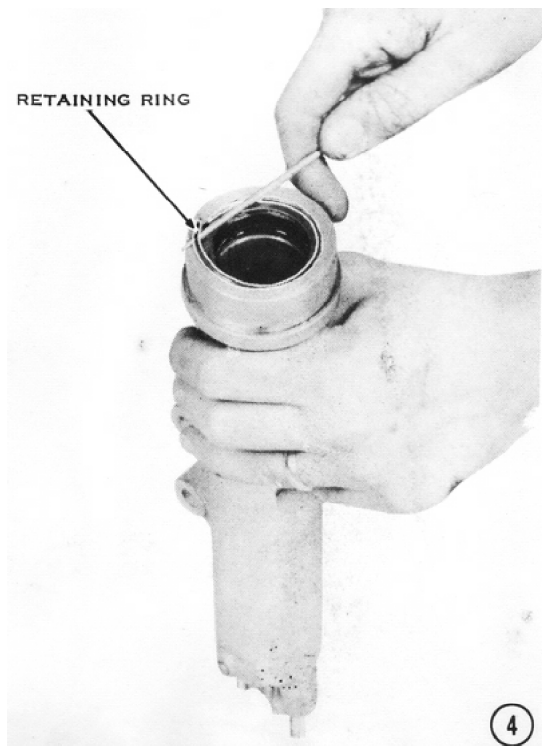
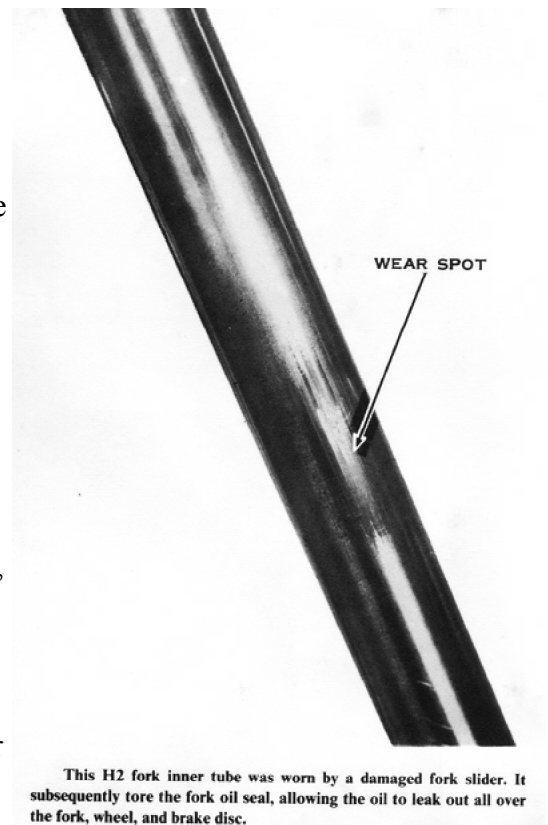



5) If the seal must be replaced, pry it out with a suitable tool such as a large screwdriver with a slightly rounded tip. **CAUTION: Take care not to damage the soft aluminum slider.** Use the old seal as a tool with a hammer to drive the new one into place. The old seal will protect the new one from the hammer and distribute the force of the hammer blows evenly.



5

6) When the new seal is fully seated, insert the washer (shown here) and the retainer ring, which fits into a groove at the top of the slider. **CAUTION: Be sure the ring fits properly into the groove. If it does not, the seal will work its way out and the fork leg will leak oil.**

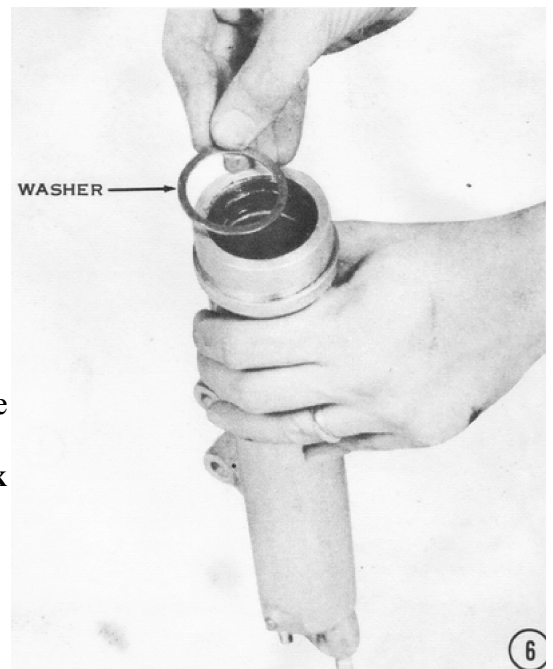

6

7) Push the rubber dust cover down over the end of the slider. Be sure it fits into the groove on the outside of the slider. *NOTE: Early types of dust covers have a single taper angle. If possible, use the later types of dust covers with a double taper, they will do a much better job.*



8) Insert the fork cylinder into the bottom of the inner tube. If the fork cylinder piston has a phenolic ring around it, the cylinder can be inserted by tipping it back and forth in the end of the inner tube while pushing it in gently. When the cylinder fits into the inner tube, push the damping mechanism and other assorted parts into the end of the inner tube. Refit the circlip. **CAUTION: Be sure the circlip is properly seated. If it comes out, the front wheel can fall off the motorcycle while you are riding.**

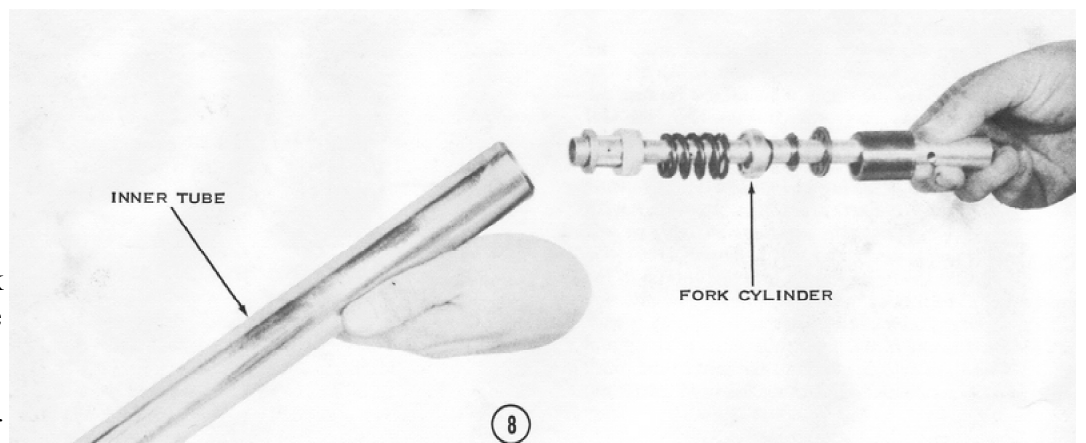

9) Put the fork spring and all spacers and spring seats into the top of the fork tube. then temporarily screw in the fork top bolt. This will hold the fork cylinder in place during the following steps.



10) Slip the small conical aluminum compression stop onto the bottom of the fork cylinder.

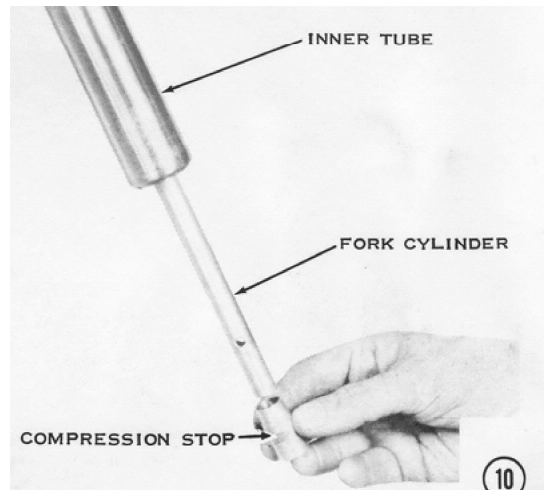

11) Carefully push the slider over the inner tube until you feel the fork cylinder touch the lower end of the slider. Insert the Allen bolt with its washer and tighten it securely.

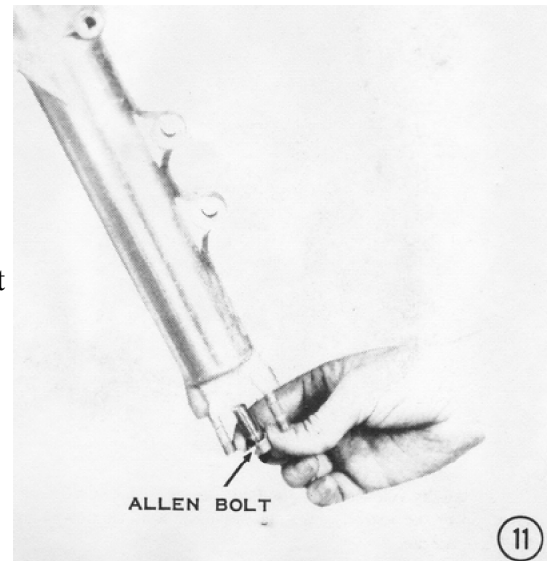

12) Now remove the fork top bolt and pour in the recommended quantity of good quality SAE 10W fork oil. Check the specification tables at the end of this chapter for oil quantities and levels. **CAUTION: Do not use motor oil; it will foam when the forks work back and forth and they will lose their damping action, in which case the motorcycle could become uncontrollable.**



Replace the fork top bolt, then tighten it and the top triple clamp bolts securely. Remount the brake caliper, front fender, and front wheel, in that order. Torque the brake caliper mounting bolts to 20 ft-lbs. and the axle clamp nuts to 14 ft-lbs. **CAUTION:** Be sure the axle clamp caps mount to the end of the fork leg so there is no gap at the front and an even gap at the rear. Tighten the front nuts first, then the rear ones.

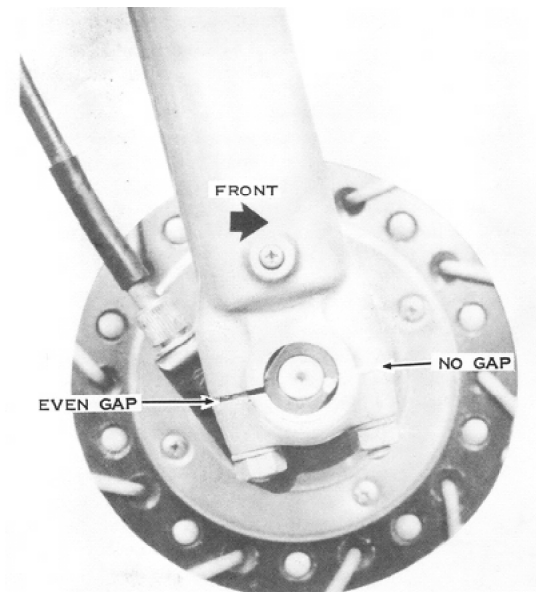

Install the axle clamp cap so that there is no gap at the front and an even gap at the rear. Tighten the front nut first, then the rear, to 14 ft.-lbs. of torque.

## REAR SHOCK ABSORBERS

The rear shock absorbers are combined spring-damper units which support and cushion the rear of the motorcycle frame. The top eye of each shock absorber is mounted on the frame, whereas the bottom eye is mounted on the trailing end of the swingarm. When the motorcycle is driven over a bump, the rear wheel lifts the swingarm. The shock absorber springs are then compressed between the swingarm and the rear of the frame. The hydraulic dampers resist the spring's natural tendency to oscillate after compression, which would cause a pitching, bouncy ride.

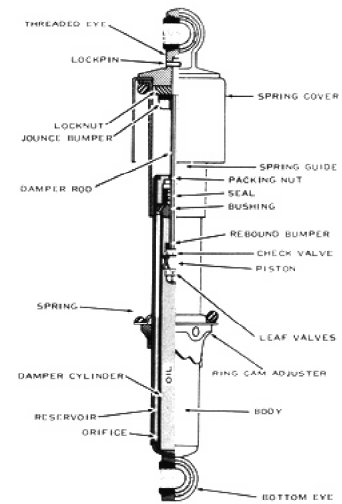

A cross-section of the typical rear shock absorber. It is double-walled and has damping valves in the piston and the bottom of the tube.

## REMOVING

Support the motorcycle on the center stand. Remove the acorn nuts from the upper shock eyes and the two bolts holding the bottom eyes to the swingarm. Push the bottom shock eyes to the rear and out of the swingarm brackets. The rear wheel will drop to the floor. Pull the upper ends of the shocks sideways from the studs on the frame.

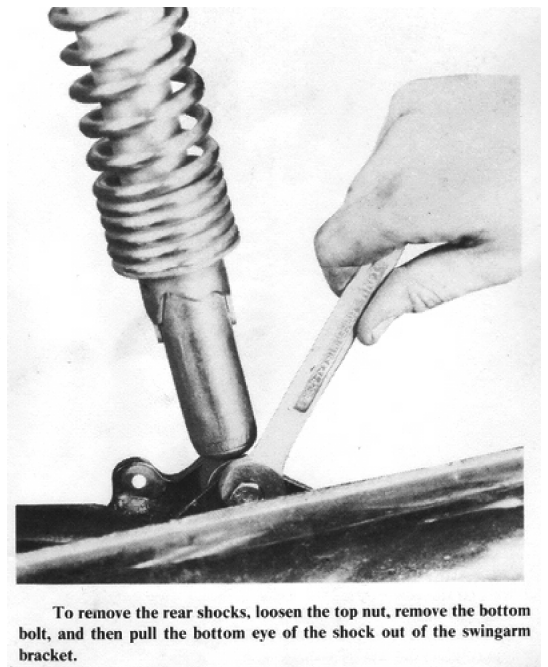

To remove the rear shocks, loosen the top nut, remove the bottom bolt, and then pull the bottom eye of the shock out of the swingarm bracket.

## INSPECTING

To inspect the shock absorbers, hold them vertically on the floor in the same position as on the motorcycle. Press down on the top eye as far as you can, then release it suddenly. The shock absorber should return to its extended length smoothly. If it returns quickly so that the bottom eye bounces off the floor, the damping mechanism is defective and the entire shock absorber unit must be replaced. *NOTE: When one unit is replaced, the other must be replaced also to balance the damping and springing forces on both sides of the swingarm.* The standard shocks cannot be disassembled or repaired; they are sealed units.

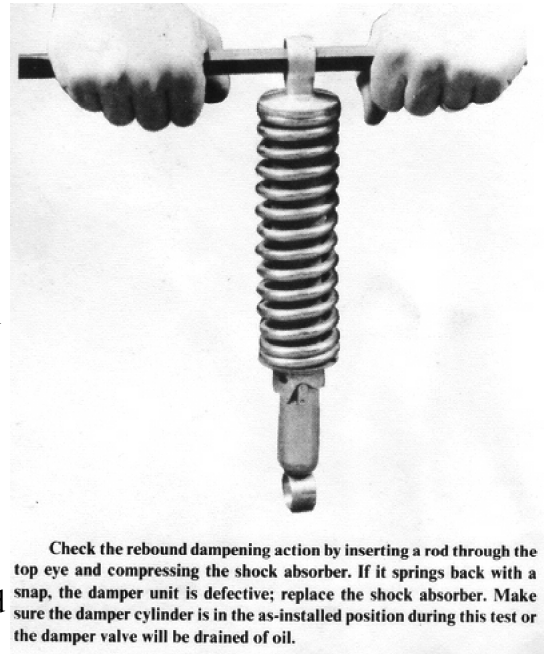

Check the rebound dampening action by inserting a rod through the top eye and compressing the shock absorber. If it springs back with a snap, the damper unit is defective; replace the shock absorber. Make sure the damper cylinder is in the as-installed position during this test or the damper valve will be drained of oil.

## INSTALLING

Install new shock absorbers in pairs, as explained previously. The large tubular end of the unit mounts to the swingarm, the other end to the frame. **CAUTION: The shock absorbers must be mounted right side up or they will not dampen properly.**

To mount the shock absorber, push the upper shock eye onto the stud on the frame. A large flat washer, a lockwasher, and the acorn nut go on next, but do not tighten the nut yet. Lift the rear wheel, then push the bottom shock eye into the bracket on the swingarm. Insert the bolt with a lockwasher and tighten it securely. Repeat the procedure with the other shock absorber, then tighten both acorn nuts securely.

## REAR SWINGARM

The front of the swingarm pivots on a large bolt which is solidly mounted through the frame tabs just behind the engine. The up-and-down motion of the trailing end of the swingarm and wheel is controlled by the shock absorbers, which are fastened to the swingarm brackets and to the frame. The swingarm performs two

functions: it keeps the rear wheel aligned with the frame, and it transmits the rear-wheel driving and braking forces to the motorcycle frame through the pivot bolt.

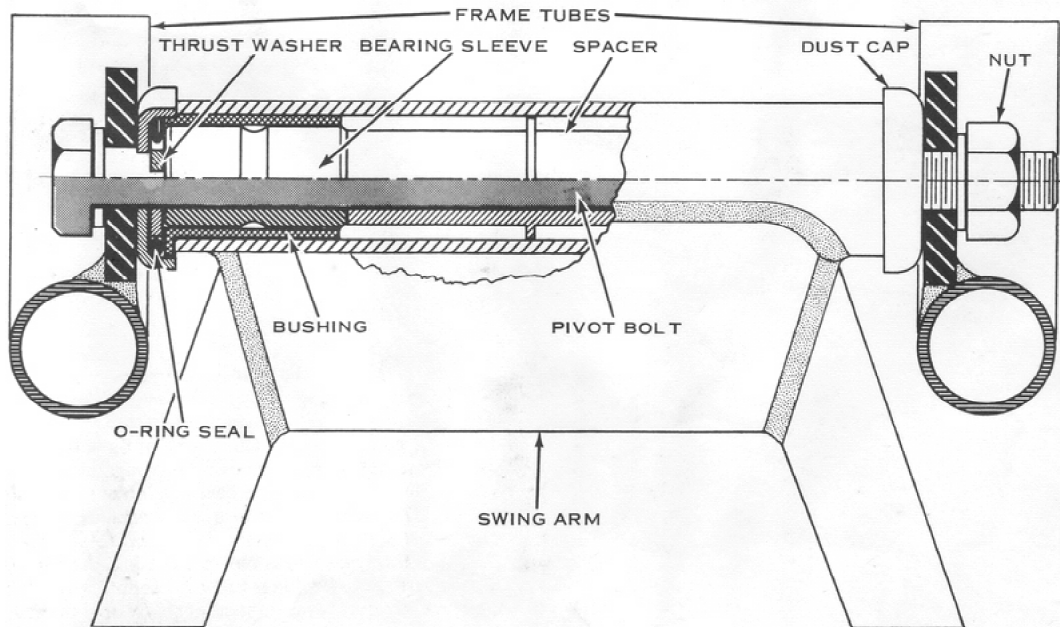

Cross-section of the swingarm installed in the frame. Tightening the bolt locks the dust caps, thrust washers, bearing sleeves, and the spacer between the frame lugs. The swingarm's bushings pivot on the bearing sleeves as the rear wheel moves up and down in the frame. Lateral play of the swingarm is determined by the side clearance between the collars of the swingarm bushings and the thrust washers.

#### ❖ LUBRICATION

The swingarm bushings should be lubricated every 2,000 miles. Loosen the swingarm pivot bolt to provide clearance for the old grease to escape from the bearings. Use a grease gun to force chassis-type lubricant into the grease fitting on the swingarm pivot tube. Stop when clean lubricant flows out around the dust covers on each end of the pivot, indicating that all the old grease has been displaced.

#### ❖ INSPECTING FOR WORN BUSHINGS

Hold the rear part of the frame, then push and pull sideways on the wheel at the top and the rear. There must not be more than 1/8" to 3/16" movement of the rear part of the swingarm with respect to the frame. If there is excessive movement, you must remove the swingarm and replace the bushings and sleeve bearings in the swingarm pivot. *NOTE: Worn wheel bearings will allow movement of the wheel with respect to the swingarm. CAUTION: Make sure the swingarm is moving, not just the wheel.* The swingarm pivot bushings will wear abnormally if the motorcycle is started and stopped abruptly or if the rear wheel is not balanced or is out of round. Rapid wear of only the left bushing is caused by an incorrect adjustment of the drive chain or by a badly worn chain and sprockets, which applies alternating heavy and light forces to the left swingarm pivot bearing.

#### ❖ REMOVING

Support the motorcycle on the center stand and remove the rear wheel. This will entail removing the chain case cover and the engine sprocket on models with endless chains (with no master link). Remove the shock absorbers. Take off the pivot bolt nut, then slide the pivot bolt, out of the frame and swingarm. Pull the swingarm free of the frame.

## INSPECTING THE SWINGARM ALIGNMENT

Insert the pivot bolt with the sleeves and the axle (with any collars) into the swingarm. Sight across the two shafts to see if the swingarm is bent or twisted, which will cause the rear wheel to be cocked in the frame. Rear wheel misalignment results in uneven tire wear, excessive chain and sprocket wear, possible tire interference with the fender, and steering pull. Replace the swingarm if it is damaged. *NOTE: If these symptoms occur but the swingarm is in good condition, the cause is a warped frame.*

## INSPECTING AND REPLACING SWINGARM BUSHINGS AND SLEEVES

Slip the sleeves out of the bushings in the swingarm. Measure the outside diameter of the sleeves and the inside diameter of the bushings still in the swingarm pivot tube. Compare the measurements with the specifications at the end of this chapter. If the outer diameter of the sleeve is smaller than the service limit, or if the inside diameter of the bushing is larger than the service limit, or if the surface of either the sleeve or the bushing is galled or scored, then both the sleeves and the bushings must be replaced.

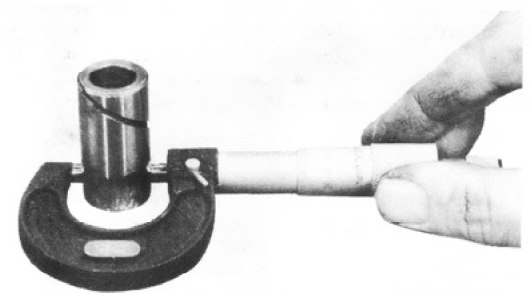

Measure the outside diameters of the swingarm bearing sleeves, then compare them to the specifications given at the end of this chapter.

To remove the bushings, drive them out of the swingarm pivot tube with a long pin punch and a hammer. Heat the pivot tube with boiling water to expand it slightly, then push the new bushings into place.

**CAUTION: Be sure the shoulder seats against the end of the pivot tube or the swingarm won't fit into the frame.** Grease the outside of the sleeves with chassis-type lubricant, then slip them into the bushings with the spacer between.

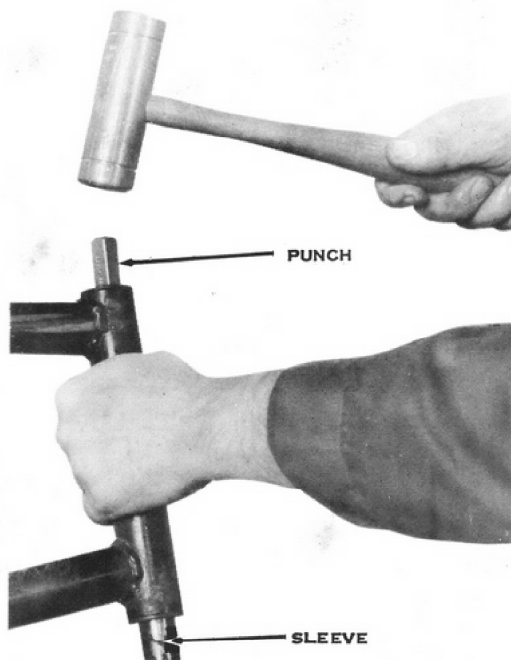

Drive out the bushings (and the sleeves, if they're stuck) with a long pin punch from the other end of the swingarm pivot tube.

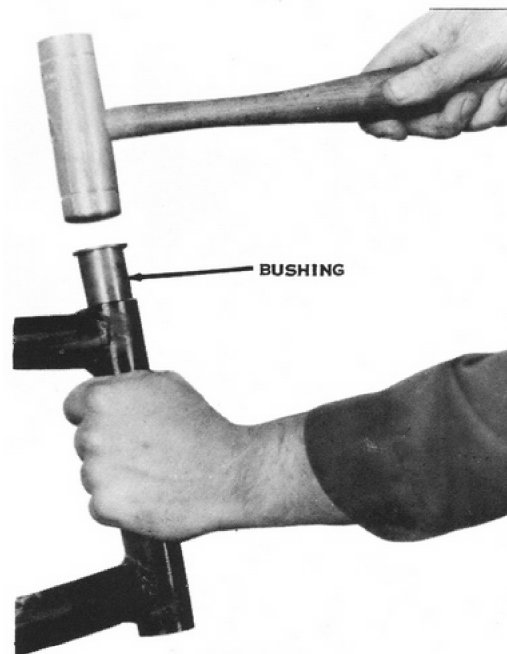

Install new swingarm bushings by heating the pivot tube with hot water, then driving the bushing in with a soft-face hammer.



To check the pivot bolt for bowing or bending, roll it along a flat surface. If the pivot bolt has a bow of more than 0.5mm (0.020") in the middle for H-series machines, or 0.2mm (0.008") for S-series machines, it must be replaced. Insert the pivot bolt into the holes in the frame lug and check for excessive clearance between the bolt shaft and the holes in the frame. *NOTE: Worn frame lug holes are caused by driving with a loose swingarm pivot bolt.*

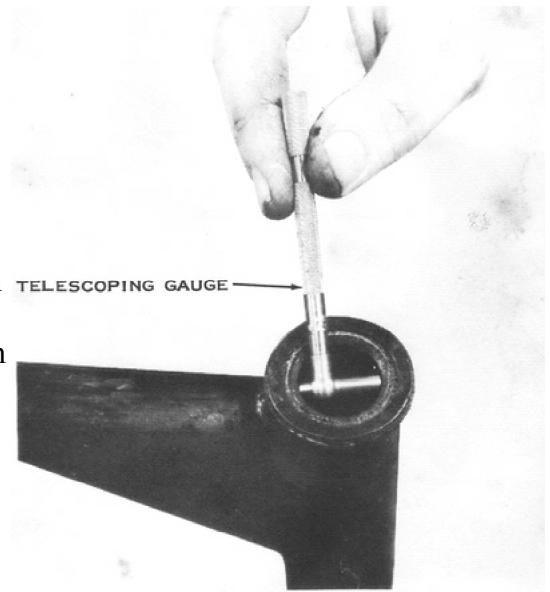

TELESCOPING GAUGE

Measure the inside diameters of the swingarm bearing bushings while they are mounted in the swingarm pivot tube. Compare the measurements to the specifications given at the end of this chapter.

## INSTALLING THE SWINGARM

When the bushings and sleeves have been installed in the swingarm pivot tube, liberally apply thick grease to the inside of the dust covers, then stick them on the ends of the swingarm pivot tube. *NOTE: Before installing the swingarm in the frame on models with an endless chain, loop the chain over the swingarm pivot tube.* Hold the swingarm in place between the frame lugs, and then push the pivot bolt into place. Install the self-locking nut with a flat washer and tighten it to 58 to 87 ft-lbs. of torque.

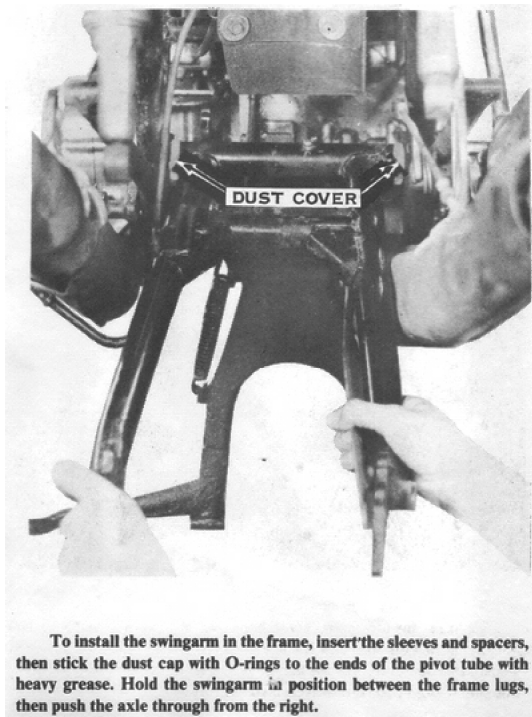

To install the swingarm in the frame, insert the sleeves and spacers, then stick the dust cap with O-rings to the ends of the pivot tube with heavy grease. Hold the swingarm in position between the frame lugs, then push the axle through from the right.



Tighten the swingarm pivot bolt with a torque wrench to the specifications mentioned in the accompanying text. If the swingarm is loose, the motorcycle will not handle properly. If it is too tight, the pivot will bind and give the motorcycle a rough ride.

Complete the installation by replacing the shock absorbers, rear wheel, and chain, and then adjust the drive chain tension and the rear brake.

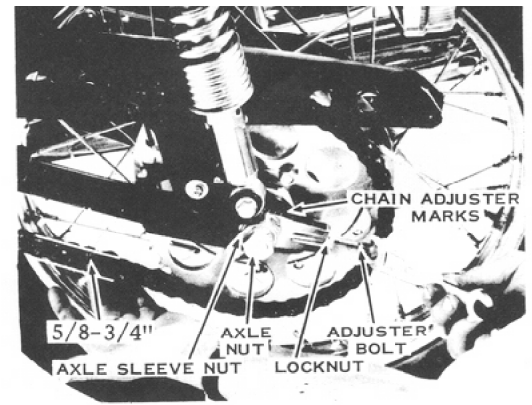

To adjust the drive chain, loosen the rear axle nut, axle sleeve nut, torque link nuts, chain adjuster nuts, and the brake rod nut. Turn the adjusters an equal amount on each side and keep the adjuster marks on the same swingarm tab alignment marks on both sides to keep the wheel and sprocket properly aligned in the frame. Be sure to tighten the adjuster locknuts, sleeve nut, axle nut, and torque link nut in that order. Readjust the rear brake.

## ADJUSTING THE DRIVE CHAIN TENSION

The chain should have about 5/8" to 3/4" up-and-down movement in the lower run of chain, halfway between the sprockets, while the motorcycle is on the center stand. Turn the rear wheel until the tightest part of the chain is at the bottom run.

If the chain does not have the required amount of up-and-down movement, you must move the rear axle forward (for more slack) or backward (for less slack) in the swingarm. To adjust the drive chain tension, loosen the rear brake torque link nuts, rear axle nut, rear axle sleeve nut (H1, H1A, H1B, and H1C only), chain adjuster locknuts, and rear brake rod adjuster nut (H1D, H1E, and H2 models). Turn both adjuster bolts the same amount until the chain has the correct amount of slack. Be sure you are adjusting to the tightest part of the chain, or else the chain will be too tight part of the time.

After adjusting the drive chain, tighten the chain adjuster locknuts, axle nut, axle sleeve nut, torque link nuts, and brake rod nut, and then check the chain tension again to be sure it has not changed.

## LUBRICATING THE DRIVE CHAIN

The drive chain is a roller-type. As the chain goes around each of the sprockets it must flex because each link rotates on the pins a little. A small amount of oil between the side plates and rollers of the chain before you ride insures a good supply of lubrication to minimize wear. Use a heavy oil such as SAE 90-weight gear oil or SAE 40 motor oil. The heavy oil sticks to the chain; a light oil will be thrown off.

## BRAKE SYSTEM

All models have internal-expanding type, mechanically-actuated, single-leading-shoe drum brakes at the rear. The H1, H1A, H1C, S2, and all the S1 models have an internal-expanding type, mechanically-actuated, double-leading-shoe drum brake at the front. All other models have a hydraulically-actuated, floating-caliper disc brake at the front. All front and rear drum brakes are actuated by a cable, except the rear brakes on the H1D, H1E, H1F, and H2 models, which have a tension rod. The rear brake on all models is activated by a foot pedal on the right side of the frame, the front brake by a hand lever on the right handlebar.

## DRUM BRAKE OPERATION

The single-leading-shoe rear brake is very simply constructed. The drum is integral with the rear wheel hub. The open side of the drum is covered by the brake panel, which carries two brake shoes. One end of each shoe rests on the cam, the other on the anchor pin. When the brake pedal is depressed, the cable or rod pulls on the actuating lever, which is fastened to the cam. As the cam is twisted, it forces the ends of the brake shoes apart, pressing their friction-lining-covered faces against the inside of the drum. The resulting friction slows the rear wheel. Heavy tension springs between the shoes hold them in place on the cam and anchor pin and retract them when the brake pedal is released.

The single-leading-shoe brake gets its name from the fact that it has one leading shoe and one trailing shoe. The leading shoe is the one whose leading end is actuated by the cam. When the motorcycle is rolling forward with the brake applied, the leading shoe supplies most of the stopping power because it is partially self-actuated by rotation of the drum. It follows, then, that a double-leading-shoe brake would have more stopping power for the amount of force applied to the actuating lever because it would have two shoes instead of one being partially self actuated by the rotation of the drum. The double-leading-shoe brake has two cams and two anchor pins on its panel, arranged so that both shoes are leading shoes when the bike is moving forward.

The brake panel is locked to the motorcycle frame to prevent its twisting around the axle with the drum when the brake is applied. The rear brake has a torque link between the panel and the swingarm. The front brake panel has a notch in it that engages a tongue on the inside of the left fork slider on the S2 and the S1 models and on the right fork slider on the H1 models. When the brake is applied, the torque link is under tension. **CAUTION: These torque-reaction devices must be carefully installed and frequently inspected. If a torque link bolt falls out, or if the panel notch is not properly meshed with the slider tongue, the panel will twist around the axle and tear off the brake and speedometer cables. The brake will lock up and cause skidding and loss of control, because the panel will be pulling on the cable or rod, thereby increasing the brake shoe pressure.**

#### DRUM BRAKE SERVICE

Drum brakes on 1974 and later models can be inspected without removing the wheel from the motorcycle. To check brake wear, apply the brake fully and watch the travel of the Brake Wear Indicator pointer. If it passes beyond the "Usable Range," the brake shoes must be replaced.

To check earlier models (1969-1973) for brake wear, remove the wheel and pull the brake panel out of the drum. Use a caliper or finely graduated scale to measure the thickness of the brake lining material on the shoe. If it is less than 3mm (0.12") on the H-series models, or 2mm (0.08") on the S-series models (at the thinnest place), the shoes must be replaced.

Measure the inside diameter of the drum and compare it to the specifications at the end of this chapter. If the measurement is greater than the service limit, the brake drum must be replaced.

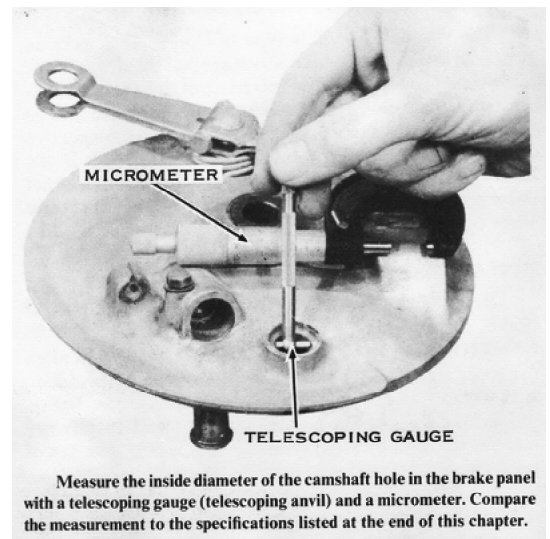

Measure the length of the brake springs and compare them with specifications. If the length of the springs is greater than the service limit, they will be too weak to retract the shoes properly and must be replaced. **CAUTION: Weak springs can allow the brakes to lock unexpectedly, or not release when the pedal or lever is released.**

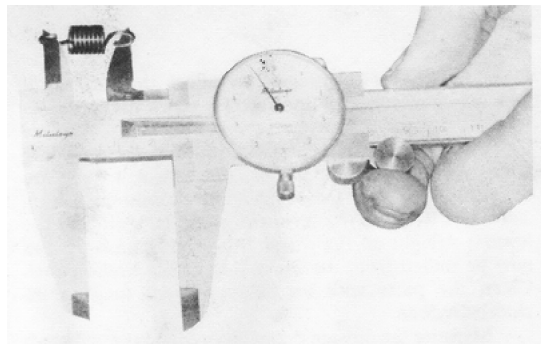

Use a caliper to measure the free length of the brake shoe return springs. *NOTE: The specified length is taken from the inside of one eye to the inside of the other eye as shown.* If the spring is stretched, from either overheating of the brake or from long use, it must be replaced to insure positive return of the brake shoes after each application.

Make aligning punch marks on the brake-actuating levers and the ends of the camshafts. This will allow you to reinstall them in the same relative positions during assembly. Remove the lever clamp bolts, then pull the lever(s) straight off the camshaft(s). The camshafts can now be pulled from the inner side of the brake panel. Clean the parts with an oilless solvent such as trichloroethylene.

Measure the outside diameter of the brake camshaft where it passes through the panel and the inside diameter of the camshaft hole in the panel. If the shaft measurement is smaller than the service limit, the camshaft must be replaced. If the camshaft hole in the panel is larger than its service limit, the panel must be replaced. *NOTE: If the panel is worn this badly, it is best to buy the entire panel assembly, which comes complete with brake cams, shoes, and springs.*

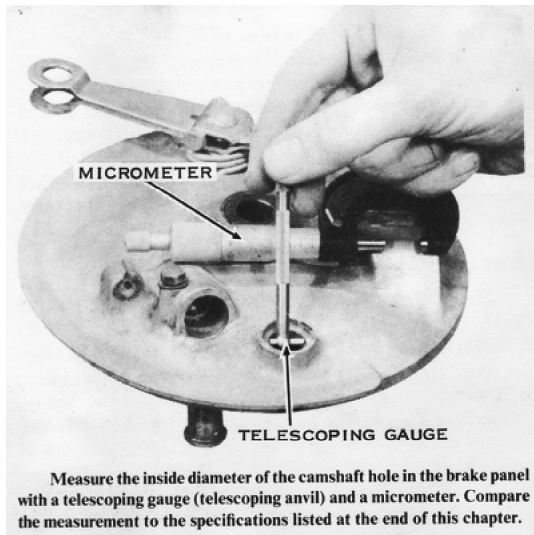

Measure the inside diameter of the camshaft hole in the brake panel with a telescoping gauge (telescoping anvil) and a micrometer. Compare the measurement to the specifications listed at the end of this chapter.

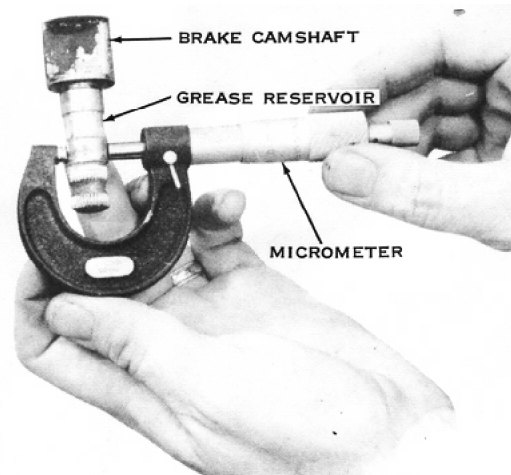

Measure the brake camshaft outside diameter on either side of the lubricant groove, then compare it to the specifications listed at the end of this chapter.

## ASSEMBLING

Smear a very light film of grease on the face of the cams and a thicker coat in the reservoir groove of the camshaft. Slip the camshaft into the hole in the panel. From outside the panel, loop the felt dust seal over the shaft, then push the actuating lever onto the shaft so that the punch marks align. Insert the clamp bolts and tighten them securely.

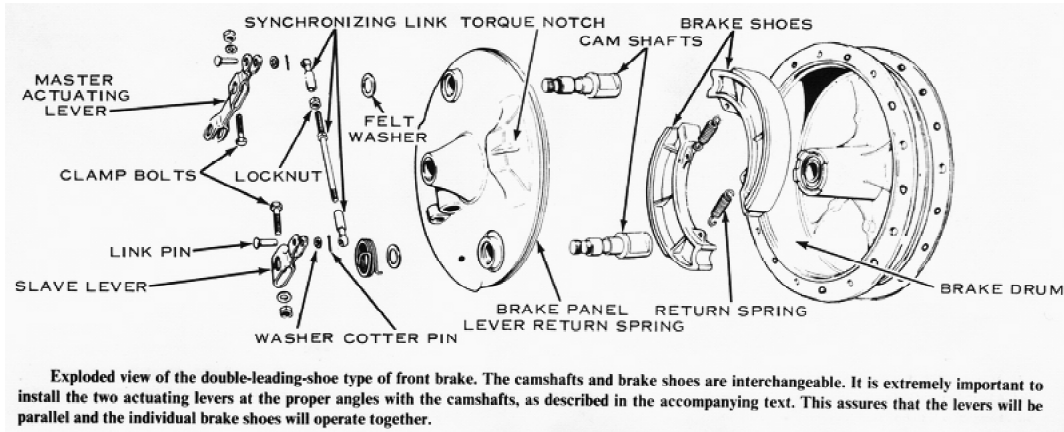

Connect the springs to the brake shoes so that when they are installed on the panel the open hook of the spring will be toward the panel. **CAUTION: If the hook on the end of the spring is installed toward the drum, it could catch on the rotating drum and be torn off.** Now push the shoes down over the cam(s) and anchor pin(s) until they snap into place. Wipe all excess grease from inside the brake assembly before installing it in the drum.

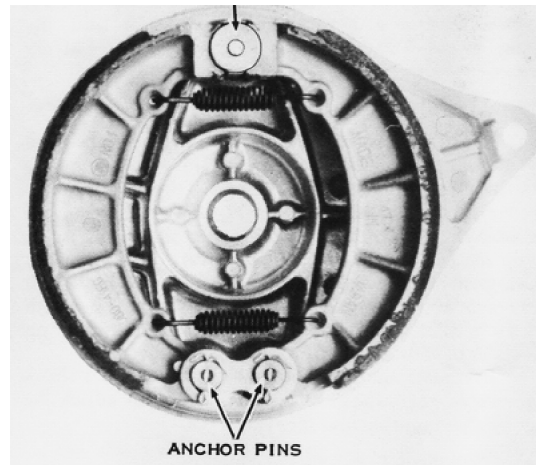
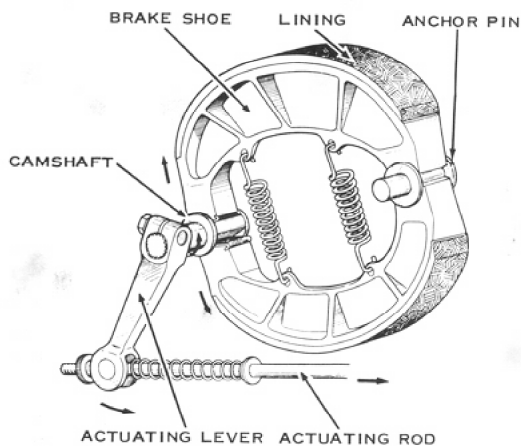

## ■ EQUALIZING A TWIN-CAM BRAKE

The two cams on this type of brake must work in unison to apply both brake shoes against the drum at the same time. To equalize the mechanism, loosen the lock nut on the threaded synchronizing link. Turn the link so that both brake shoe pads lie flat on their respective cams, and then tighten the locknut. **CAUTION: If the link is incorrectly adjusted, one brake shoe will contact the drum prematurely, causing uneven wear and erratic brake operation.**

## ■ INSTALLING

Remove any loose parts inside the brake panel and brake drum, then install the panel in the wheel. **CAUTION: On front wheels, take special care to align the speedometer drive tangs with the notched wheel hub.** **CAUTION: Loose parts could jam inside the brake, which would cause the wheel hub and panel to fracture and the wheel to lock up, resulting in skidding and loss of control.**

Install the wheel on the motorcycle as described in the section of this chapter on wheel hubs and bearings, but do not tighten the axle nut at this time. On rear wheels, fasten the torque link to the panel by inserting the shoulder bolt through the panel strut, turning it so that the bolt head drops into the hex socket in the strut. Rotate the panel on the axle so the strut is at the 5 o'clock position as viewed from the right side of the motorcycle. Slip the torque link over the bolt, then secure it with a flat washer, lockwasher, and nut. Push the safety spring clip into the grooved section of the bolt threads. Check to be sure the forward end of the torque link is securely fastened to the swingarm.

To connect the cable-type linkage, insert the cable end through the lug on the brake panel and slip the rubber boot (with the enclosed spring) over the cable. Position the link pin in the actuating lever, then guide the cable end through the pin. Screw on the adjuster nut with the ramps facing the link pin. *NOTE: Check the side play of the adjuster nut in the lever ears, which must be 1/16-3/32".* Bend the lever ears to obtain the proper side play. **CAUTION: If the adjuster nut has excessive side play (caused by spreading of the lever ears), the link pin could fall out of the lever, resulting in an inoperative brake.** *NOTE: Some models have the cable end drilled to accept a cotter pin, which must be installed at this time.* Stretch the rubber boot to engage its lip with the nipple on the cable sheath.

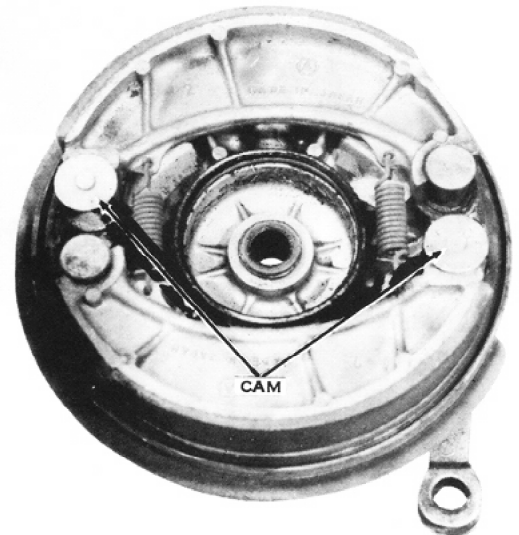
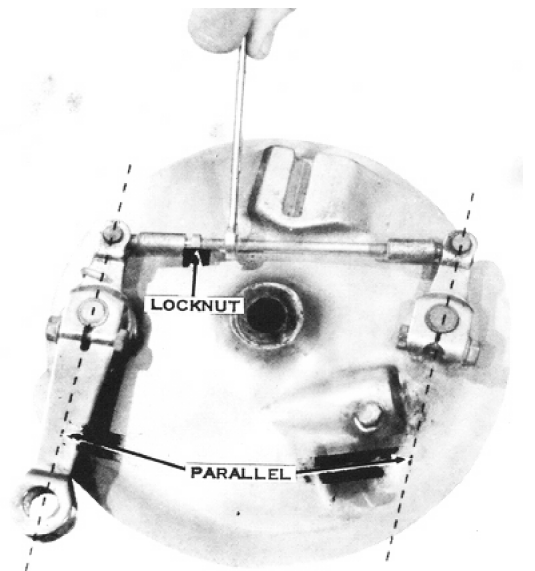

To equalize a twin-cam brake, loosen the locknut on the synchronizing link and turn the link so that both brake shoe pads lie flat on the cams. After an adjustment, tighten the locknut. Check to see that the levers are parallel after an adjustment, as shown in the top illustration.

To connect the rod-type linkage, slide the washer and spring onto the brake rod, and then position the link pin in the actuating lever. Push down on the brake pedal, guide the rod through the link pin, then release the pedal. Screw on the adjuster nut with the ramps facing the link pin. **CAUTION: Don't forget to install the washer on the brake rod before installing the spring. Otherwise, the spring will slide up the rod, relieving tension on the adjuster nut. Vibration and road shock could then cause the adjuster nut to slip out of the lever ears and the link pin to fall out of the lever, rendering the brake inoperative.** Check to make sure that the forward end of the brake rod is secured to the brake pedal and that the brake pedal is held on its pivot shaft by a washer and cotter pin or circlip. Operate the brake pedal to check for a sticking pivot, which could cause the rear brake to drag and the brake linings to overheat.

#### ❖ CENTERING THE BRAKE PANEL

It is important to center the brake panel in the drum while tightening the axle nut. This prevents new linings from dragging on the drum and assures maximum brake effectiveness with the shortest burnishing period. *NOTE: It usually requires 200-400 miles of use for the new brake linings to conform to a brake drum.* To center the brake panel, block up the wheel and spin it rapidly. Apply the brake panel or lever firmly and hold it while tightening the axle nut.

#### ❖ ADJUSTING THE FRONT BRAKE

If the brake lever comes closer than 1" to the handgrip when the front brake is applied, or if you can squeeze the lever until it touches the handgrip, the front brake must be adjusted. First loosen the locknut on the brake cable adjuster at the brake lever. Now screw the adjuster as far into the lever bracket as it will go, then tighten the locknut. Turn the adjuster nut on the end of the cable at the brake panel until the brake lever has the desired amount of free play. The front brakelight switch does not require an adjustment.

#### ❖ ADJUSTING THE REAR BRAKE PEDAL POSITION

Before adjusting the rear brake, first set the brake pedal's rest position. To do this, loosen the adjuster locknut on the right side of the frame and turn the adjuster so that the pedal rests in a comfortable position for the rider. **CAUTION: Don't position the pedal so high that your foot rests on it, or the battery will discharge from the brake lamp being continually lit.** Tighten the locknut to secure the adjustment.

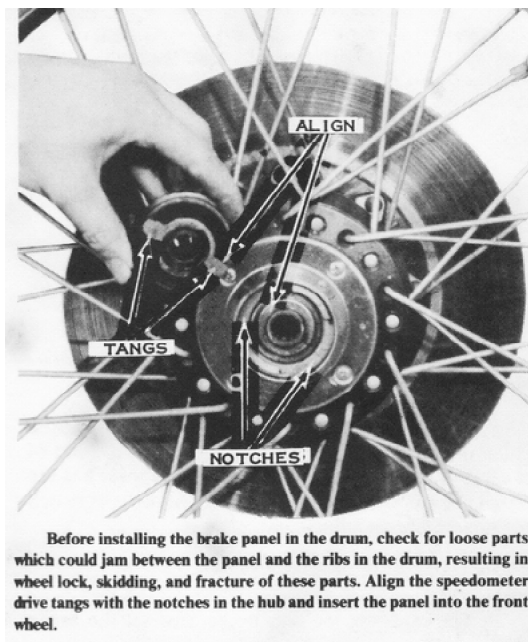

### ADJUSTING THE REAR BRAKE

Turn the adjuster on the rear brake cable or rod so that the pedal travels 3/4"-1" when the brake is applied. **CAUTION: Make sure there is 1/2" frame clearance for additional pedal travel; otherwise, loss of braking could result under hard usage.**

*NOTE: On all models with rod-type brake linkage, recheck the brake adjustment each time the axle is moved for taking up chain slack.*

### ADJUSTING THE REAR BRAKE LIGHT SWITCH

After adjusting the rear brake, you must adjust the rear brakelight switch to be sure that the brake lamp will light when the brake pedal has been depressed 1/2" to 3/4". The brake lamp must light before the brake becomes effective.

To adjust the switch, loosen the two adjuster nuts on the body of the switch. Move the switch up or down, holding it in your fingers, until the brake lamp lights at the right time. Now turn the adjuster nuts to lock the switch into that position. **CAUTION: Overtightening the adjuster nuts can break the switch body and short out the lighting system, which will burn out the main fuse.** When you have tightened the adjuster nuts, check the adjustment again by pushing down on the brake pedal.

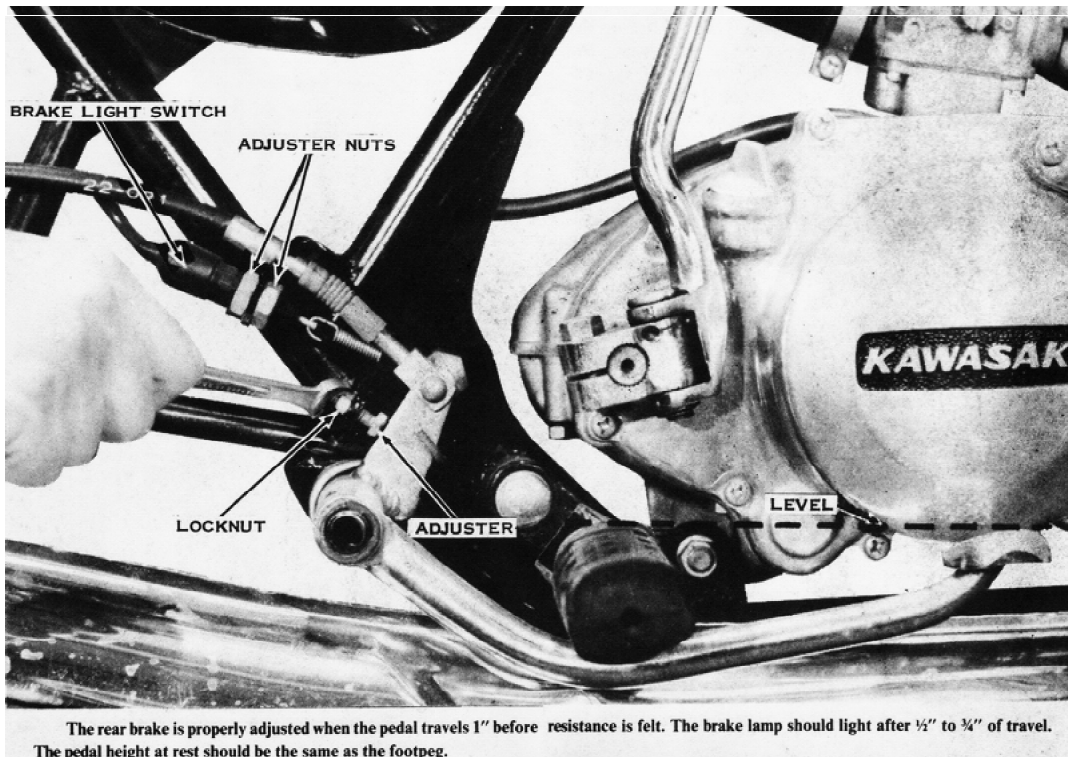
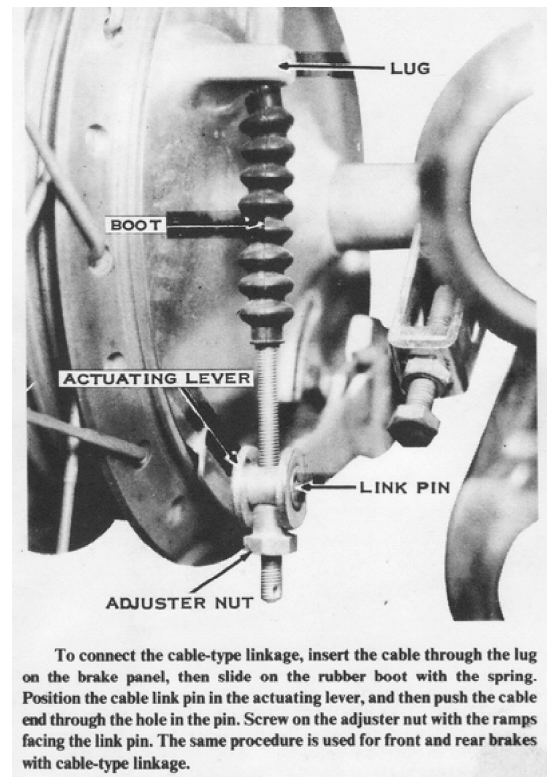



## DISC BRAKE OPERATION

All disc front brakes are hydraulically operated. The master cylinder-and-reservoir assembly is mounted on the right handlebar. The brake disc is mounted on the left side of the wheel hub, and the single-piston floating caliper is mounted on the left fork slider. A system of steel and flexible brake lines connects the master cylinder to the caliper.

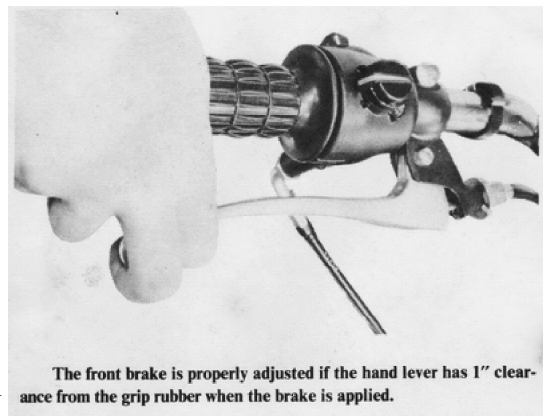

When the rider squeezes the brake lever, the master cylinder piston is pushed through the cylinder, compressing the brake fluid ahead of it. The pressure of the brake fluid is transmitted equally throughout the entire hydraulic system. The brake lamp switch is turned on by this pressure, and the piston in the caliper is also moved by the pressure. As the caliper piston moves out, it forces one brake pad against the disc. The caliper slides in the other direction until the pad on the back side also presses against the disc. The two pads pinch the rotating disc between them and the resulting friction slows the front wheel.

The difference in size between the master cylinder piston and the caliper piston is what gives the rider the strength to squeeze the disc hard enough to stop the motorcycle. The area of the face of the caliper piston is about eight times as large as the area of the master cylinder piston; this gives the rider an eight-to-one force advantage. The brake lever is designed to give the rider an additional five-to-one mechanical advantage over the master cylinder piston, for a total advantage ratio of forty to one. If the rider squeezes the hand lever with a force of 25 pounds, the pads are forced against the disc with a force of 1,000 pounds.

## DISC BRAKE SERVICE

Because of the high pressures involved, hydraulic system service is very critical. Be very careful to keep all parts as clean as possible; use only fresh brake fluid from unopened cans marked D.O.T.3 or J-1703.

## REMOVING THE PADS

When the pads have worn down to the red line on the movable pad, they must be replaced. First the front wheel must be removed. Support the motorcycle on the center stand. Unscrew the speedometer cable ring nut at the hub and then pull the cable free. Remove the axle clamp cap nuts, clamp caps, and front wheel. Remove the small screw on the wheel side of the caliper. This will allow the fixed pad to be removed through the slot in the caliper. Now there will be room to take out the movable pad. If it will not come out of its recess in the caliper, squeeze the lever carefully to force it out. Remove any shims from the back of the pad.

When the pads are both out, push the piston back into the caliper. **CAUTION: The brake fluid thereby displaced will go into the master cylinder reservoir. If the reservoir is full, it will overflow. Do not get any brake fluid on painted surfaces, as it will soften and stain the paint.**

## REPLACING THE PADS

If there were any shims behind the movable pad, put them onto the new one, then insert the pad in the caliper. *NOTE: The shim help stop brake squeal.* Now insert the fixed pad and tighten the screw securely.

Remount the front wheel. Remember to mount the axle clamp caps so there is no gap at the front and an even gap at the back. Reconnect the speedometer cable, then tighten the front two clamp nuts and then the rear nuts to 14 ft-lbs.

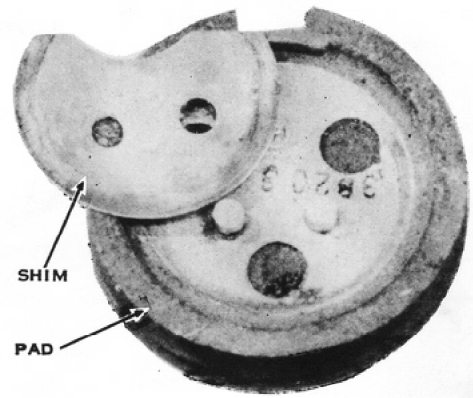

The shim behind the movable pad in the disc front brake caliper helps prevent brake squealing. It fits on the two pins in back of the pad.

Pump the brake lever a few times to push the movable pad into position. Then check that the brake fluid level is up to the line inside the reservoir.

## SERVICING THE CALIPER

There is no need to take off the front wheel to remove the caliper. The disc can be inspected while the wheel is mounted.

To drain the brake fluid, push a plastic tube over the bleeder valve on the caliper, and then put the other end into a clean container. Open the bleeder valve, and then pump the brake lever repeatedly until no more brake fluid comes out of the tube. Pull the tube off, and then close the bleeder valve.

Unscrew the steel tube fitting on the back of the caliper. Remove the two bolts holding the caliper to the fork slider. Take out the small screw on the wheel side of the caliper. This will release the stationary pad, which can be slipped out of the slot in the caliper. The movable pad can now be removed through the slot.

Use an Allen wrench to unscrew the caliper shafts. Pull the wheel side half of the caliper off smoothly, taking care not to tear the O-rings on the shafts. Pull the shafts out of the remaining caliper half the same way. The mounting bar will come off at this time.

The piston may not easily slide out of the caliper cylinder. If necessary, force it out with compressed air directed into the hydraulic pipe fitting hole. **CAUTION: If high-pressure compressed air is used, the piston may be ejected violently. Do not allow it to damage itself or anything else.** Use a hooked probe to pull the dust seal and oil seal out of the caliper bore.

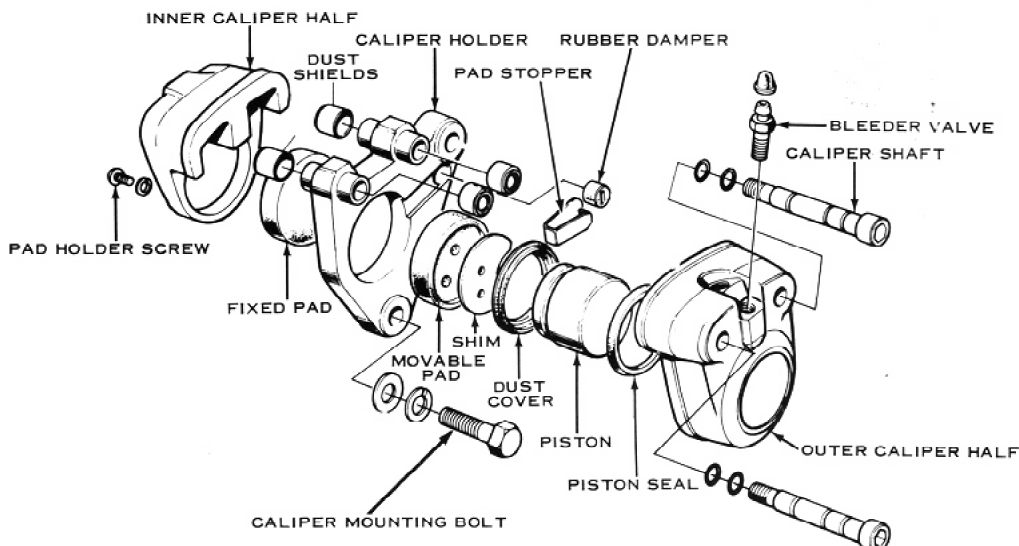

An exploded view of the disc brake caliper. **CAUTION: Never expose the rubber parts to a mineral-oil-based lubricant or solvent; it will dissolve them.**

## ■SERVICING THE MASTER CYLINDER

To disassemble the master cylinder, remove the banjo bolt holding the hydraulic fitting. Unscrew the clamp bolts, then lift the master cylinder from the handlebar.

Remove the nut on the bottom of the lever bracket, allowing the lever pivot bolt to be withdrawn from the top. Reach into the end of the cylinder with a hooked probe, then pull out the snap ring and the dust seal. The small inside circlip must be removed with a pair of circlip or retaining ring pliers. *NOTE: If a tool of this type is not available, a Kawasaki special tool (part number 57001-154), can be ordered through an authorized dealer.* Blow on the hose end of the cylinder to remove the piston stopper, piston, cups, spring, and check valve assembly. **CAUTION: Do not disassemble the piston and check valve any further. If any replacements are required, only subassemblies are available.**

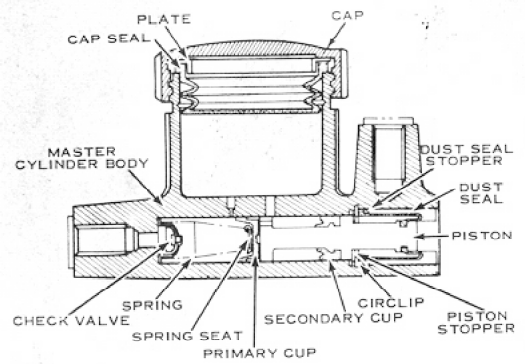

This is a cross-section drawing of the master cylinder used on all disc brake models. Use this as an aid in assembling the master cylinder.

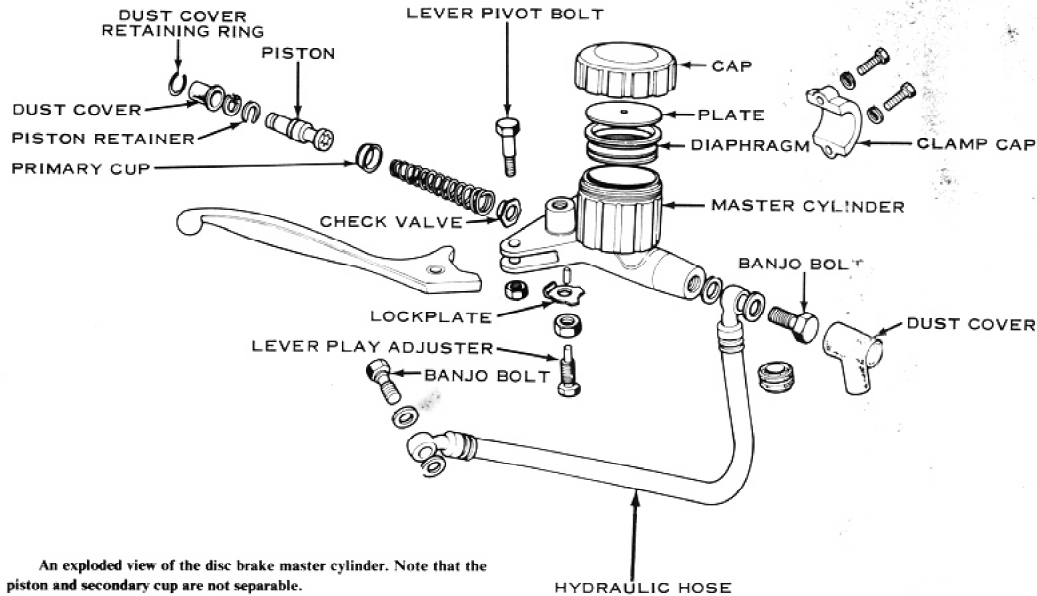

## CLEANING AND INSPECTING

Clean all the parts of the caliper and master cylinder with clean brake fluid or alcohol. **CAUTION: If alcohol is used, do not immerse rubber parts for more than 30 seconds, or they will be dissolved.**

Inspect all the rubber parts carefully for scratches, cuts, and tears, any of which are cause for replacement. *NOTE: The rubber cup on the master cylinder piston is not replaceable by itself. The entire piston must be replaced.*

Look for scratches, shiny wear spots, rust, and pitting on the metal parts like the two pistons and inside the master cylinder and caliper bores. Be sure the two holes in the bottom of the reservoir are clean.

Measure the inside diameter of the caliper and master cylinder bores at several places. If any of these dimensions are greater than the service limits at the end of this chapter, the part must be replaced. Measure the outer diameter of the caliper piston, master cylinder piston, and its two cups. If any of these measurements are less than the service limit, the part must be replaced.

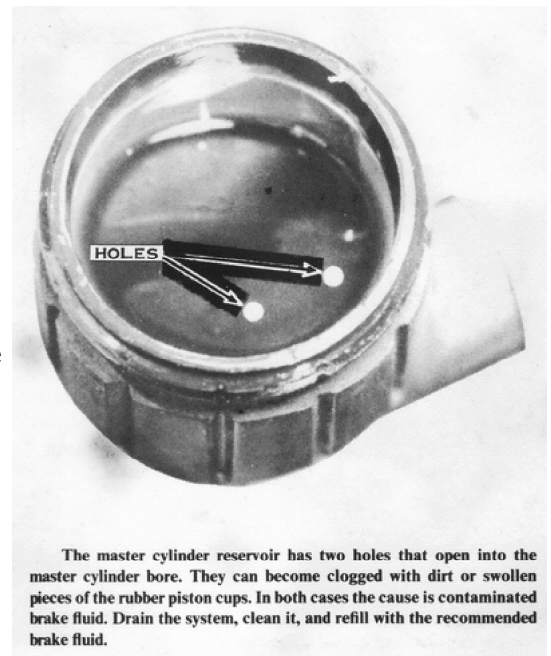

The master cylinder reservoir has two holes that open into the master cylinder bore. They can become clogged with dirt or swollen pieces of the rubber piston cups. In both cases the cause is contaminated brake fluid. Drain the system, clean it, and refill with the recommended brake fluid.

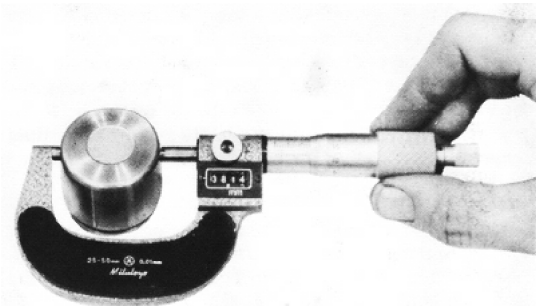

Measure the diameter of the caliper piston at several places with a micrometer. Compare the measurements to the specifications given at the end of this chapter. Check for scratches and worn spots, too.

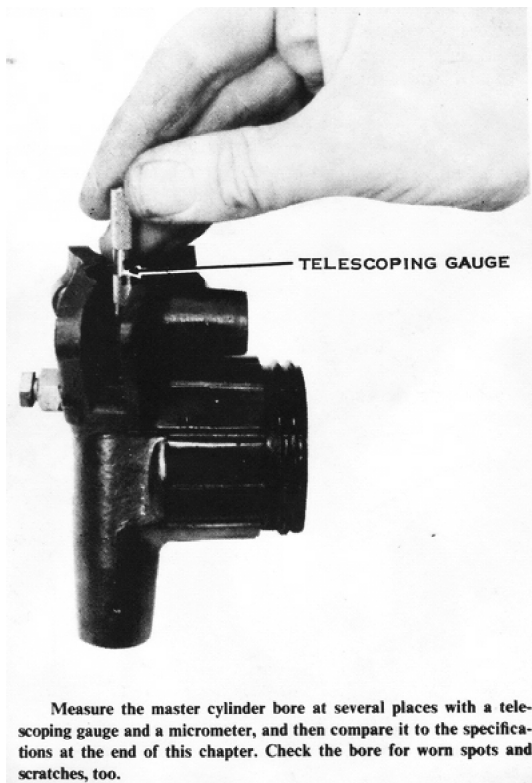

Measure the master cylinder bore at several places with a telescoping gauge and a micrometer, and then compare it to the specifications at the end of this chapter. Check the bore for worn spots and scratches, too.



Measure the caliper bore at several places with a telescoping gauge and a micrometer, and then compare the measurements to the specifications at the end of this chapter. Check the bore for worn spots and scratches, too.

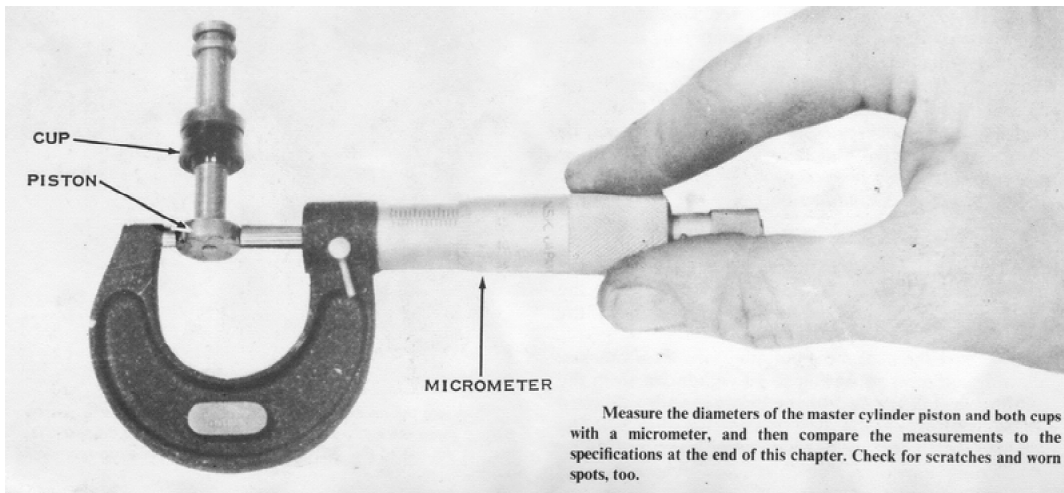

Measure the free length of the master cylinder spring. If it is less than the service limit, it must be replaced. If any of the rubber parts are swollen or lumpy, they must be replaced.

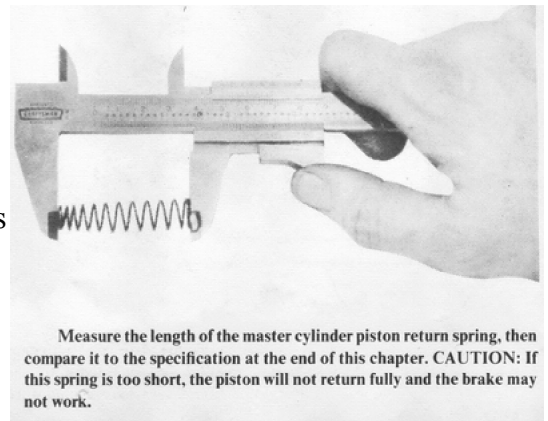

Inspect the pads for grease or dirt embedded in the friction surface. If either pad is worn to the red line, replace both pads. Clean the pads with oilless solvent such as trichloroethylene to remove oil or grease from the friction material. If they will not clean up properly, replace them. *NOTE: If the pads are worn unequally, replace all the seals in the caliper and master cylinder.* The adjuster seal (caliper oil seal) may be worn out, or the relief port in the master cylinder may be clogged by swollen pieces of a broken seal.

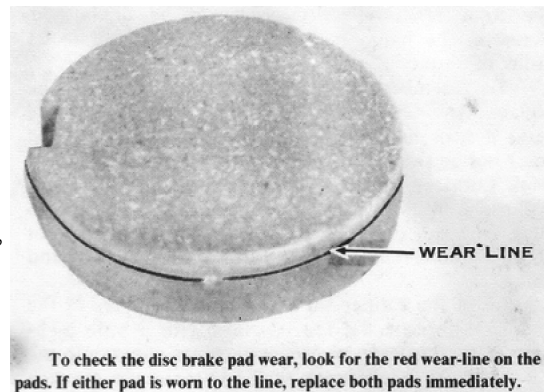

Bend and twist all the rubber brake hoses and look for cracks or bulges, which indicate replacement is needed. If there are any visible leaks, replace the affected line or gaskets (if the leak is at a fitting). The steel brake pipes must be replaced if they are rusted, cracked, or if the plating is badly scratched. **CAUTION: This type of damage weakens the pipe and it can burst under braking pressure, leaving you without brakes.**

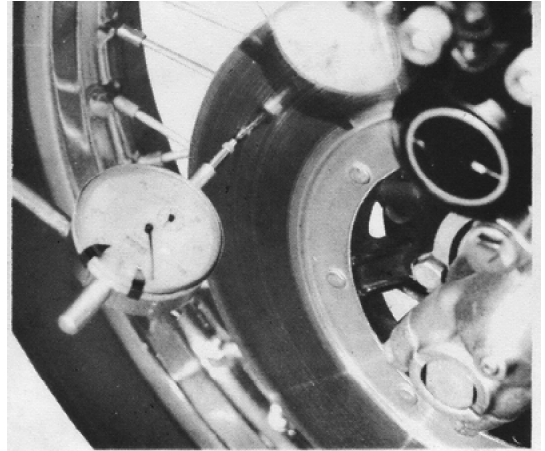

Measure the amount of disc runout with a dial gauge on a stand. Turn the wheel slowly and watch the needle for the total reading. Compare it with the specifications at the end of this chapter.

Measure the thickness of the disc at the point of most visible wear. If it is less than 5.5mm (0.217"), the disc must be replaced. To check the disc runout, spin the wheel with a dial gauge held against the side of the disc. If the total indicated runout is greater than 0.3mm (0.012"), the disc must be replaced.

## ASSEMBLING

If you replace the disc, it is a good idea to change the pads at the same time. Clean the new disc thoroughly with trichloroethylene or other oilless solvent. The disc is packaged with a rust-preventive coating which will lower the friction coefficient of the pads if not removed completely. Replace the lock plates under the disc mounting bolt heads, and then torque the disc bolts to 14 ft-lbs. Be sure to bend up the edges of the lock tabs to secure the disc-mounting bolts.

To assemble the master cylinder, hold it with the bore vertical and with the hose fitting end down. Drop the check valve in so that the rounded side is up. Push the large end of the spring down over it. Work the primary cup (the loose one) into the bore with the cupped side down. **CAUTION: The cup must be squeezed in. If it goes in loosely, it won't seal, and the brake won't work.** Push the piston in (after the primary cup) with the large end down. You will have to squeeze the secondary cup as well. **CAUTION: Be sure neither cup is turned inside out or they will leak and the brake won't work.** Drop the piston stopper washer in behind the piston. Use the circlip pliers to insert the circlip in the bottommost groove. Force the dust cap into the bore (big end first) until the piston shows out the small end. Insert the snap ring as far into the bore as possible to hold the dust seal in place.

Mount the master cylinder on the right handlebar with the small bump on the edge of the clamp cap toward the right-hand switch case. This will properly space the master cylinder from the switch case to prevent hand lever travel from being limited by the switch case. **CAUTION: If the clamp cap is installed backward, the front brake effectiveness could be diminished.** Screw in the banjo bolt fitting and tighten it to 21 ft-lbs. of torque.

To assemble the caliper, start by pushing the square, cross-sectioned oil seal into the caliper bore until it seats in the groove. **CAUTION: The oil seal must not be twisted in the groove or the brake will not work.** Lubricate the piston with the same brake fluid you will use to fill the system, then slip it into the bore with the hollow side out. Snap the dust cover over the end of the piston so that it engages the grooves in the piston and caliper.

Insert the caliper shafts through the holes in the caliper. Lubricate the four O-rings with a little high-temperature waterproof grease, then slip them onto the caliper shafts, one in each of the two grooves on each shaft. Push the large end of each dust seal over the projections on the sides of the caliper-mounting bar. Hold the caliper half in your left hand with the piston toward the right; hold the mounting bar in your right hand with the fork mounting bolt holes toward you and the large brake pad hole facing down. Slip the two parts together so that the shafts go into the dust covers, through the mounting bar, and out the dust covers on the other side. Push the shafts into the mounting bar holes gently so that the O-rings are not damaged. Be sure the mating surfaces of the caliper halves are absolutely clean, and then fit the halves together. Screw in the shafts and tighten them to 24 ft-lbs. of torque. **CAUTION: If the mating surfaces are not clean, the caliper halves will not fit together properly, and the brake may lock the wheel and cause a skid.**

Fit the shim to the back of the movable pad so that it goes onto the pins. Slip the pad between the caliper halves, then into the hole in the caliper-mounting bar. Push it in as far as it will go. Now push the fixed pad into place in the other caliper half, insert the screw with a lockwasher, and tighten it securely.

Mount the caliper on the fork leg so that it straddles the disc. Insert the chrome-headed bolts with lockwashers and flat washers, then tighten them to 21 ft-lbs. of torque. Screw in the hydraulic pipe fitting, then tighten it to 12 ft-lbs. of torque. Check that all other fittings and plugs are tightened to the torque specifications given at the end of this chapter.

#### BLEEDING THE HYDRAULIC SYSTEM

Fill the reservoir with extra-heavy-duty brake fluid from an unopened can marked D.O.T.3 or J-1703. **CAUTION: Disc brake fluid gets very hot in use. If you use improper or contaminated fluid, the brake could fail.** Close the bleeder valve and attach a plastic tube to it. Immerse the other end in a container of used brake fluid.

Pump the brake lever repeatedly until some resistance is felt. Hold the lever against the grip, then momentarily open and close the bleeder valve. Now pump the lever again and repeat the procedure until no more bubbles come through the tube from the bleeder valve and the lever "feel" hardens. **CAUTION: Keep the reservoir full of brake fluid during this operation. If the level drops too far, air will be sucked into the system, and the bleeding operation will be extended, thus wasting fluid.** If you have the double-disc accessory on your H1 or H2 model, you will have to bleed both calipers separately.

#### WHEEL HUBS AND BEARINGS

The front-wheel hub on drum-brake models is mounted on two ball bearings, one on each side. A bearing spacer is used between them to support the inner races when the axle nut is tightened. A shielded bearing is used in the open side of the brake drum to prevent abrasive lining particles from causing premature wear and to keep wheel-bearing grease from fouling the brake. An oil seal, axle spacer, and dust cap are used on the opposite side of the hub to keep dirt from wearing out the unshielded bearing.

The front-wheel hub on disc brake models is mounted on two ball bearings, one on each side. A bearing spacer is used between them to support the inner races when the axle shaft is tightened. The H-series models

have an oil seal, a spacer, and a dust cover on the right side of the hub, and an oil seal and the speedometer drive gearbox on the left side to keep the lubricant in the bearings. The S-series models have an oil seal and the speedometer drive gearbox on the right side of the hub, and an oil seal, a spacer, and a dust cover on the left. This is because the center of the smaller diameter S-series disc is not large enough to allow the speedometer drive gearbox to be mounted inside it.

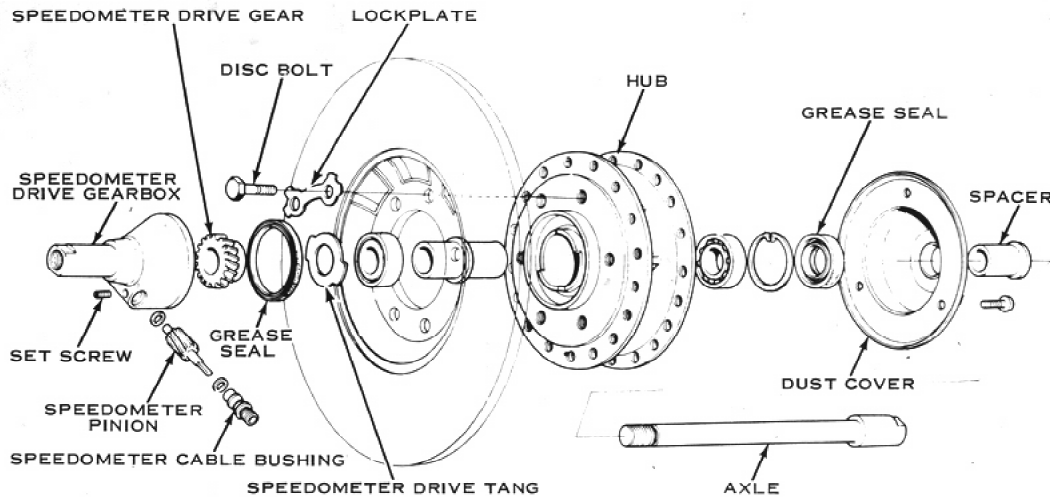

An exploded view of the H-series front disc brake hub. Use it as an aid to reassembling. Note that the speedometer drive gearbox is on the left side with the disc.

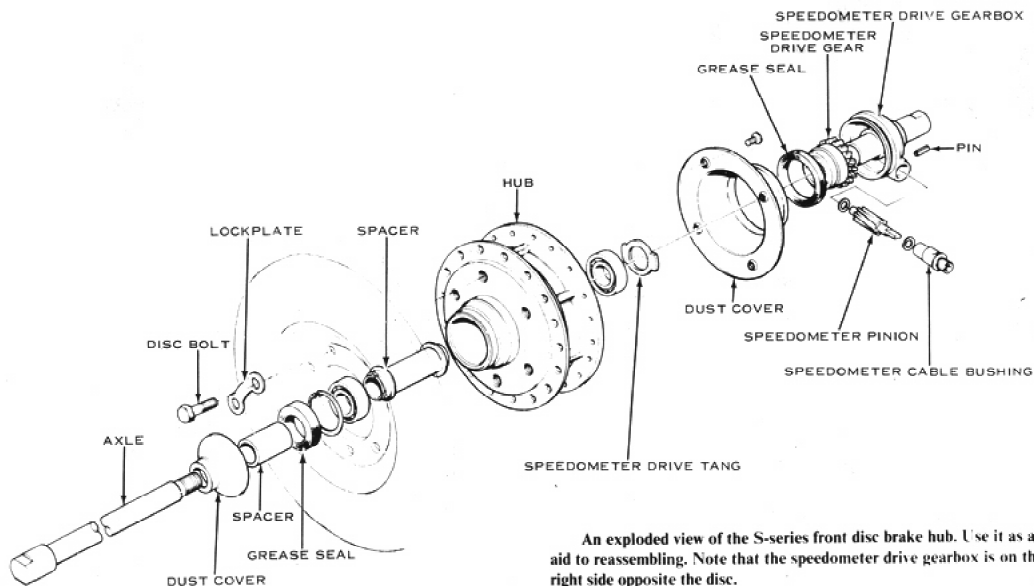

An exploded view of the S-series front disc brake hub. Use it as an aid to reassembling. Note that the speedometer drive gearbox is on the right side opposite the disc.

A two-piece hub is used on the rear wheel. The sprocket is mounted on a carrier that drives the hub through four rubber torque shock dampers. The wheel hub is supported on the axle by two bearings with a spacer. The sprocket carrier has its own bearing, which is mounted on an axle sleeve in S-series, H1, H1A, H1B, and H1C models, and on the axle in all other models. The separate axle sleeve is fastened to the left side of the swingarm by a large nut with a flat washer, allowing removal of the rear wheel hub without disturbing the chain. The intermeshed metal vanes of the wheel hub and sprocket carrier are separated by the torque shock absorber rubber segments. When an abrupt drive or coast loading is transmitted through the torque shock absorber, the rubber segments are crushed between the vanes, and this reduces chain and spoke stresses.



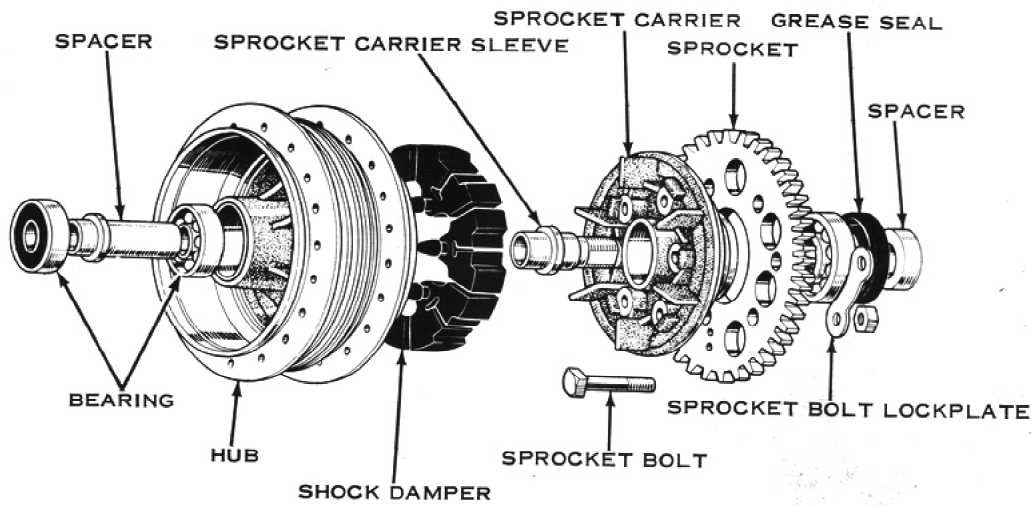

An exploded view of the S-series rear hub as an aid to assembling. Note the axle sleeve and nut on the left, in the sprocket carrier. The H1, H1A, H1B, and H1C hubs are very similar.

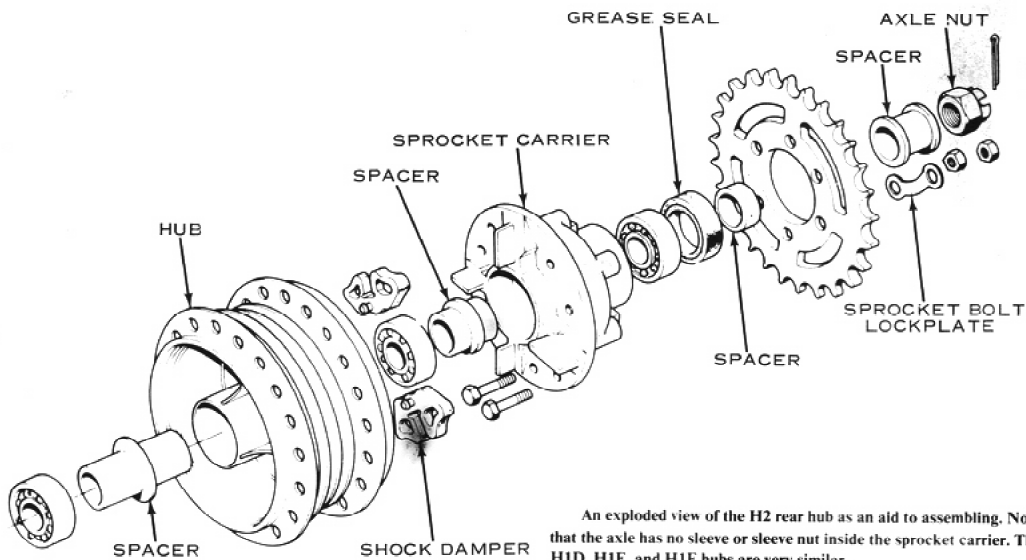

An exploded view of the H2 rear hub as an aid to assembling. Note that the axle has no sleeve or sleeve nut inside the sprocket carrier. The H1D, H1E, and H1F hubs are very similar.

## REMOVING

Take off the wheel. On models so equipped, remove the sprocket carrier by loosening the large nut on the axle sleeve and then lifting the carrier from the swingarm. Pry out the oil seal from the hub, then use a broad blunt punch to drive the wheel bearings out of the hub. To remove the first bearing, insert the punch through the inner race of the opposite bearing. Tilt the spacer inside the hub and position the end of the punch against the bearing.

To remove the front disc brake hub bearings, remove the front wheel, then unscrew the axle using a pair of 19mm open-end wrenches. Remove the dust cover, spacer, and speedometer drive gearbox. The disc need not be removed to drive out the bearings as described above, but be careful not to damage the disc.

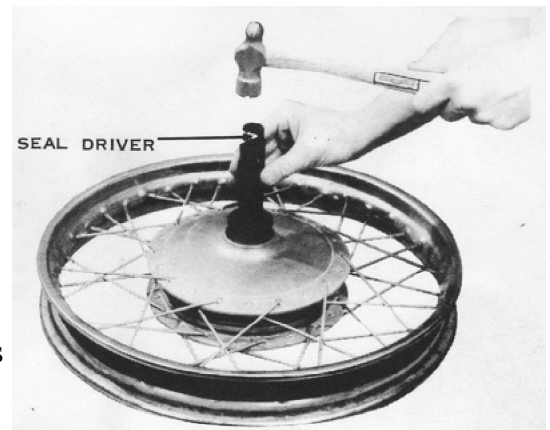

It is best to install the hub oil seals with a bearing driver, but the old seal may be used instead. The marked side of the seal must face outward.

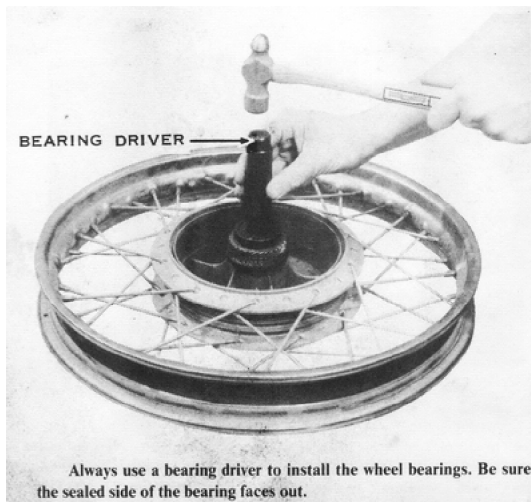

Always use a bearing driver to install the wheel bearings. Be sure the sealed side of the bearing faces out.

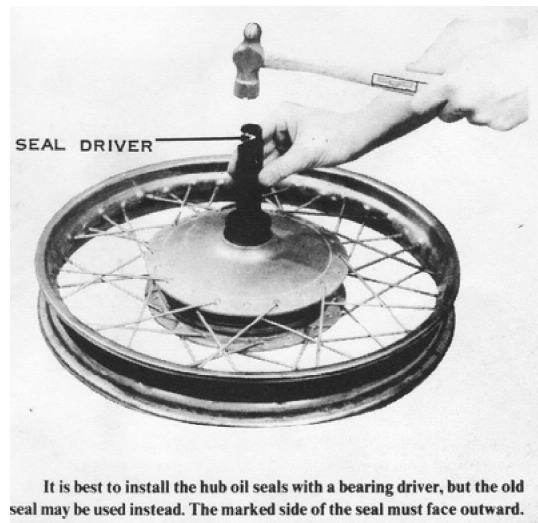

It is best to install the hub oil seals with a bearing driver, but the old seal may be used instead. The marked side of the seal must face outward.

## 🔧 CLEANING AND INSPECTING

Wash the bearings by soaking them in a mesh basket suspended in a container of clean petroleum solvent or kerosene. Allow them to soak for at least six hours to soften hard deposits. Use a stiff, clean brush to remove all foreign material, rinsing the bearing after each brushing. Dry the bearings with filtered, dry, compressed air. **CAUTION: Don't spin the bearings with the compressed air or they will be damaged from insufficient lubrication or dirt.** *NOTE: The sealed or shielded bearings require repeated washing to insure satisfactory removal of all contaminants.*

Hold the inner race and slowly turn the outer race in both directions to check for chipped balls or damaged races. Replace any wheel bearing that has more than 0.020" side play or noticeable radial play. If a bearing is

determined to be usable, immerse it in 10W oil and rotate it to displace entrapped solvent. **CAUTION: To prevent rust from attacking the precision-finished parts of the bearing, keep the interval from cleaning to lubrication as short as possible.** If the bearing is not to be installed immediately, coat it with a rust-inhibiting oil and wrap it in clean oilproof paper.

Clean the inside of the hub with a cloth soaked in solvent, taking care not to contaminate the brake drum surface. Inspect the outer races of the bearings and the hub's bearing bores for signs of fretting or bearing creep. If there is evidence of movement between the bearing outer races and the hub, replace these parts. Check for wear between the bearing inner races and the axle.

Roll the axle on a flat surface to check for bending. Replace the axle if it is more than 0.020" out of true. If the oil seal lips are cut, worn, or hardened, replace the seal.

Check the torque shock absorber segments for eroding, tearing, or hardening. *NOTE: A damaged torque shock absorber segment is evidenced by noise or lurching when accelerating from a stop, the result of excessive clearance between the absorber segments and the vanes in the hub and sprocket carrier.*

## ASSEMBLING

Smear high-temperature, water-insoluble grease between the races of the bearings and inside the wheel hub. **CAUTION: Don't get any grease on the brake drum or brake shoes.** Clean all grit or particles from the bearing bores in the hub, then use a bearing driver to install the bearing in the open side of the brake drum, taking care to position it with the shielded side facing out. Turn the wheel over and insert the bearing spacer. Install the bearing with a bearing driver, taking care to position it with the shielded side facing out.

Make sure the bearings' outer races are fully seated against the ridges in the hub bore by checking for a gap between the inner race and the bearing spacer. If there is a gap, one of the bearings is not seated properly, the spacer is too short, or it has been crushed by overtightening. *NOTE: If the wheel bearings are improperly seated, there will be a gap between the brake panel and the wheel hub, and it will be difficult to slide the wheel assembly between the fork-sliders or swingarm tabs. Also, the bearings will be subjected to excessive side loadings when the axle nut is tightened.* **CAUTION: A crushed or short bearing spacer could cause the brake drum flange to rub against the brake panel rim, resulting in scorching of these parts and excessive drag.**

Install the bearing in the sprocket carrier from the outside with a bearing driver. Lubricate the outside edge of the oil seal, then use a seal driver to install it next to the bearing, with the marked side facing out.

Grease the lips of the oil seal, insert the axle sleeve into the bearing, and push the left spacer over the sleeve and into the seal, taking care not to distort the outer lip. Position the left chain adjuster (with the large holes) over the left swingarm tab. Turn the axle sleeve (on models so equipped) so that its flats align with the slot in the swingarm tab, and then push it through the chain adjuster and swingarm. Install the axle sleeve nut, but do not tighten it at this time. Connect the drive chain. On models without an axle sleeve inside the sprocket carrier, the short spacer fits into the oil seal from the inside. The torque shock absorber segments have little nipples that fit into holes in the back of the wheel hub. Push the segments into place in the hub. The wheel is now ready for mounting.

## INSTALLING THE WHEELS

To assemble the drum brake front wheel for mounting, insert the axle spacer through the seal lips, then position the dust cap over the spacer. *NOTE: To prevent squeaking, smear grease inside the seal and dust*

*cap.* Install the brake panel in the hub, taking care to line up the speedometer drive tangs. Position the large axle spacer next to the brake panel, then hold the wheel between the forks while installing the axle.

To assemble the disc brake front wheel for mounting, grease the lips of the oil seal and attach the dust cover with four screws. Push the axle through the dust cover. Slip the speedometer drive gearbox onto the axle, taking care to align the speedometer drive tangs with the notches in the hub. Screw in the axle and torque it to 55 ft-lbs. Hold the wheel between the forks, with the disc in the caliper and the ends of the axle between the studs on the bottoms of the fork sliders. Install the axle caps so there is no gap at the front and an even gap at the back. Tighten the nuts to 14 ft-lbs. of torque, first the front nuts and then the rear ones.

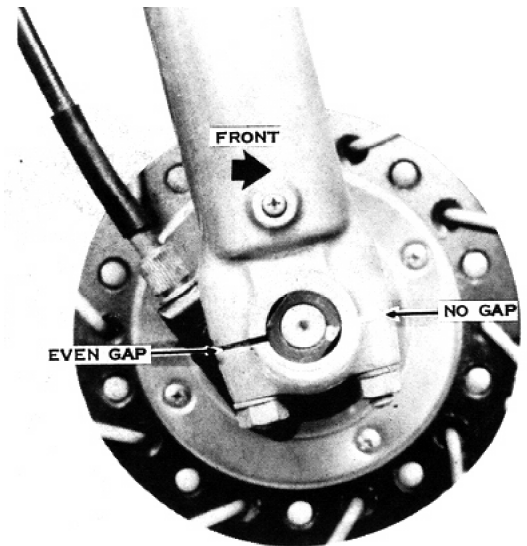

Install the axle clamp cap so that there is no gap at the front and an even gap at the rear. Tighten the front nut first, then the rear, to 14 ft-lbs. of torque.

To install the two-piece rear wheel with the axle sleeve, slide the sleeve into the sprocket carrier. Hold the left chain adjuster (with the two large holes) over the left swingarm tab, and then insert the axle sleeve through them, turning it to line up the sleeve's flats with the swingarm slot. Thread on the large nut, but do not tighten it at this time. Position the wheel hub (with the brake panel installed) next to the carrier. Position the right chain adjuster on the swingarm tab, and hold the large spacer beside it. Slide the axle through from the right side, and then install the castellated nut. Connect the chain, adjust the slack; and then tighten the axle.

To install the two-piece rear wheel without the axle sleeve, slide the sprocket carrier into the wheel hub (meshing the carrier vanes with the torque shock absorber rubber segments). Fit the brake panel into the drum. Hold the chain adjuster over the axle hole in the right swingarm tab, push the axle partway through, and then slip the spacer over the axle. Hold the wheel assembly up between the swingarm tabs, and then push the axle almost all the way through. Position the chain adjuster over the axle hole in the left swingarm tab, and then push the axle the rest of the way through. Install the castellated nut with a flat washer. Tighten the nut according to the torque specifications given at the end of this chapter.

## TIRES AND TUBES

The motorcycle's tires are extremely important for safe cornering, braking, and accelerating. The conventional pavement tire has a tread contact area less than half the size of the palm of your hand.

These models are equipped with two different types of tires, for front and rear wheels. The front tire has a narrow cross-section and a ribbed-tread pattern, which resists sideslip during cornering and offers reduced rolling friction. The rear tire has a wider cross-section and incorporates a traction-block pattern for good grip during acceleration and braking.

## INFLATION PRESSURE

Refer to the specification table for the correct inflation pressures for the front and rear tires of your motorcycle. **CAUTION: To maintain safe handling, the inflation pressures must be increased when a passenger or additional weight is carried.** Incorrect inflation pressures lead to uneven tire wear, deterioration of riding quality, and unpredictable handling; therefore, always use an accurate pressure gauge when inflating the tires.

## REMOVING A TIRE

Take off the wheel and lay it on a smooth surface with the brake drum facing down. **CAUTION: Spread a blanket underneath the wheel to prevent scratching the hub, disc, or rim.** Use chalk to mark the tire sidewall in line with the valve stem so that the tire can be matched to the rim during assembly.



Remove the valve stem nuts, then push in the stem. Use a rubber mallet to break both tire beads away from the wheel rim. Starting near the valve stem, insert the tire irons, 5" apart, under the tire bead, and then lift that section over the rim. Remove one tire iron and insert it 3" from the raised section, lifting more of the bead. Continue working around the wheel until ¼ of the bead is raised, then pull the remaining section out by hand.

Deflate the innertube by unscrewing the valve cap, reversing it, and then using the slotted end to remove the valve core. **CAUTION: Cup your hand over the valve stem to prevent losing the valve core when it flies out.** Remove the nuts from the valve stem, then push the stem inside the rim. *NOTE: The valve stem base in the innertube clamps the tire beads to the rim; it will be impossible to break the tire bead from the rim without first loosening the valve stem nuts.* Loosen and push in any tire bead clamps.

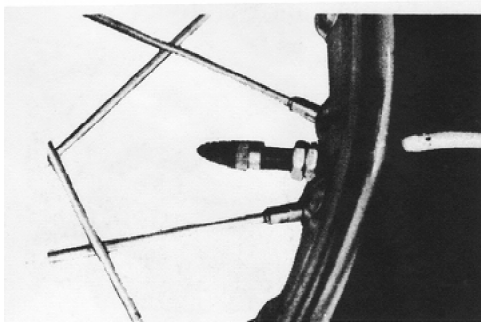

Before loosening the valve stem nuts, mark the tire sidewall in line with the valve stem to maintain wheel balance after assembly. *NOTE: On wheels with tire bead clamps, be sure to identify the valve stem hole in the rim.*

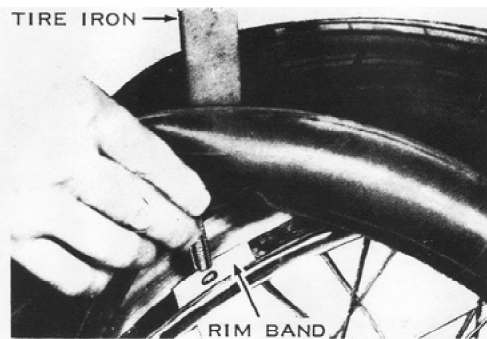

After installing one tire bead over the rim, use a tire iron to pull both tire beads to one side of the rim. Align the holes in the rim band and wheel, and then insert the valve stem. Thread on one of the valve stem nuts, but don't tighten it at this time.

Use a rubber mallet to break the tire beads away from both sides of the wheel rim. Starting near the valve stem, insert two tire irons, about 5" apart, between the tire bead and the rim. At the same time, kneel on the tire just opposite the valve stem to force the tire bead into the "dropped" center of the rim. Pry the bead up over the rim and slide one iron toward the other to disengage the rim from the bead. Insert this tire iron 3"

away from the raised section, then lift the bead over the rim. **CAUTION: Insert the tire iron only as much as is necessary to pick up the tire bead, or you will pinch the innertube. CAUTION: Don't use any sharp-edged tools, or you will damage the tire bead.**

Reach inside the tire and curl out the valve stem, then pull out the rest of the innertube. *NOTE: It isn't necessary to remove the tire from the wheel rim if you only want to repair or replace the innertube.* To remove the tire from the rim, lift the bead and take out any tire bead clamps. Push one side of the remaining bead into the "dropped" center of the rim and use the tire irons to lift the bead over the rim. Remove the rim band by stretching it over the rim.

## INSPECTING

Check the spokes to make sure none protrudes from its nipple. Remove the nipple from any protruding spoke, then file the spoke end so it will be  $\frac{3}{32}$ " shy of protruding. **CAUTION: If the spoke is left flush with the nipple, it could puncture the innertube after subsequent tightening.**

Check the inside surface of the wheel rim for rust, rough welds, or burrs which could cut the innertube. Use a file and emery cloth to remove any defects, and spray the area with enamel. Check the inside surface of the tire for punctures, cracks, or metal particles which could pinch or cut the tube. A thin patch can be used to cover a minor defect in the tire lining.

Repair the innertube if the puncture is less than  $\frac{3}{8}$ " long. Replace the innertube if the puncture is larger or if the base of the valve stem is torn. *NOTE: Such damage results from running with low tire pressure, a loose valve-stem nut, or a loose tire-bead clamp, because the tire has slipped on the rim during hard acceleration or braking, carrying the innertube around with it.*

## INSTALLING

Stretch the rim band over the wheel and position the valve stem hole over the matching hole in the rim. Make sure the rim band is the correct diameter and width for your motorcycle. If it is too narrow or small, some of the spoke nipples could contact the innertube to cause a flat tire. If it is too wide or large, it may overlap and interfere with the innertube.

Sprinkle talcum powder inside the tire to reduce friction with the innertube. Brush a soapy solution onto the tire beads, then pry one bead over the rim. *NOTE: Most new tires can be installed either way, but used tires have established a wear pattern which dictates installation in the same direction they had been used.* Reversing a used tire can prolong its life slightly, but it may result in erratic handling until the tread wear evens itself. **CAUTION: If a tire has an arrow on the sidewall, it indicates the direction of the motorcycle when the arrow is at the top of the tire, directly above the axle. Such a tire must be mounted this way on H-series models to prevent its being torn apart by the power of the engine.**

Pry down both tire beads until the valve stem hole is exposed, and insert the valve stem through the rim band and the wheel rim. Thread the nut on three turns, but don't tighten it at this time. *NOTE: Install the tire bead clamp(s), if used, in the same manner.*

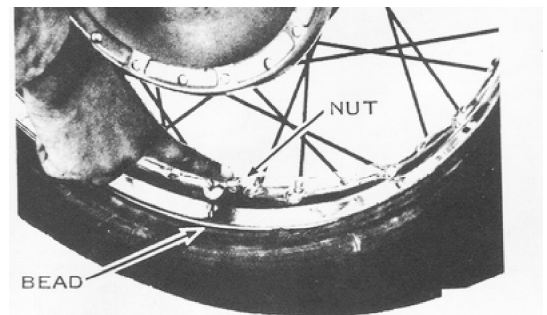

Tuck the innertube inside the tire, taking care not to twist or pinch it. Push the valve stem and any tire bead clamps away from the center of the wheel to keep them from being trapped by the tire beads during assembly. Install the remaining tire bead by hand, then use tire irons to pry the last third of the bead over the rim.

Tuck the innertube inside the tire, taking care not to twist it. Before installing the remaining tire bead, temporarily inflate the innertube to align it inside the tire. Push out the valve stem and any tire bead clamps from the wheel center, then fit the remaining tire bead by hand, starting at a point opposite the valve stem. Use tire irons to pry the last third of the bead over the rim. **CAUTION: Don't trap the clamping part of the innertube between the bead and the rim or you will pinch the tube.**

Shift the tire on the rim until the valve stem points directly to the center of the wheel. **CAUTION: If the tire is inflated with the valve stem cocked, the innertube will tear.** To maintain wheel balance, line up the chalk mark on the tire's sidewall with the valve stem. *NOTE: Some replacement tires have a dot or other mark on the sidewall to identify the lightest sector of the tire. This dot should be aligned with the valve stem and the bead clamp.*

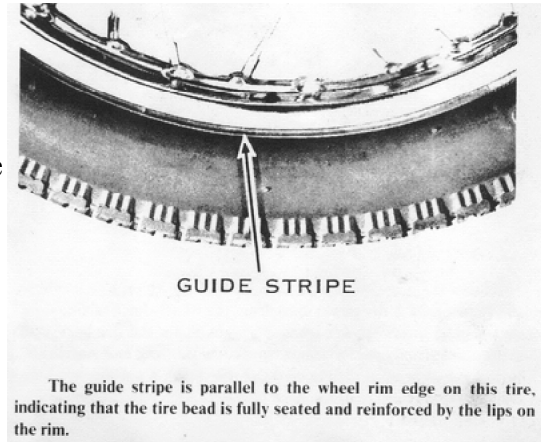

Use the valve cap to install the valve core, then inflate the tire to twice normal pressure. Rock the valve stem from side to side to release air trapped between the innertube and tire. Check for even bead seating on the rim by checking the guide stripe on the tire, which must be parallel with the wheel rim edge. Use soapy water on the rim edge, then strike the tire's sidewall glancing blows with a rubber mallet to pull the tire bead out against the rim. *NOTE: When properly installed, the tire's sidewall will be reinforced by the wheel rim. If the tire bead is not fully seated, the tire loses this lateral support and becomes too flexible.* **CAUTION: If the motorcycle is driven with a half seated tire, high-speed cornering and straight-line stability could be adversely affected. This is especially true of poorly seated rear tires.**

Deflate the tire to the recommended pressure, tighten the valve stem nut, and then secure it with the locknut. Install the valve cap. Tighten the nuts and lock nuts on any tire bead clamps. Install the wheel on the motorcycle. **CAUTION: If a new tire is installed, allow 200 miles of careful driving until the tread wears in.** New tire treads are comparatively smooth and slick from the molding process, and they lack the normal traction and cornering characteristics of used tires.

## WHEEL BALANCING

Wheel imbalance can cause wheel hop and pounding vibrations at speeds over 65 mph. As long as the original-equipment tires are used, wheel balance can be maintained by taking care to remount a tire in its original position. When a new tire or wheel rim is installed, or when the original tire has been installed haphazardly, the wheel must be rebalanced.

The wheels can be balanced without removing them from the motorcycle. Back off the brake cable adjustment so there is no drag on the brake drum. At the rear wheel, separate the chain and remove it from the sprocket. At the front wheel, detach the speedometer drive cable. Remove all factory wheel weights.

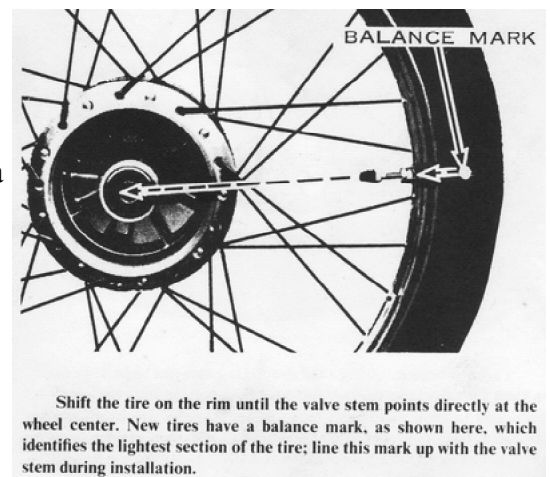

Park the motorcycle on the center stand so the wheel spins freely. Give the wheel a slight spin and let it stop of its own accord. Mark the wheel at the bottom and spin it again. If the wheel stops at the same position (mark at the bottom), it is out of balance.

Different size lead weights (10 gr. and 20 ar.) are available for balancing wheels. These are slotted to fit over a spoke, then must be clamped around the spoke nipple with a pair of pliers. As an alternative, you can wrap a length of solder around the spoke just above the nipple for balancing weight. At a point on the rim directly opposite the heavy mark make another mark and spin the wheel again. Increase the size of the weights until the wheel stops with the light mark at the bottom. Move the weights three or four spokes from the light mark and recheck the balance. When the wheel stops at random positions during three or four spins, it is properly balanced. *NOTE: The purpose of using two*

*weights and spreading them apart is to triangulate the weight concentrations around the wheel rim, rather than having two opposing heavy sectors acting on the wheel rim, spokes, and wheel hub spoke flange. Install the drive chain or the speedometer cable and adjust the brake.*



**SWINGARM SPECIFICATIONS**

H-SERIES MODELS	Standard	Service Limit
Pivot Sleeve Outside Diameter	22.0mm (0.8661")	21.85mm (0.8602")
Bushing Inside Diameter	22.15mm (0.8720")	22.40mm (0.8819")
Pivot Shaft Bend	0	0.5mm (0.02")
<b>S1 MODELS</b>		
Pivot Sleeve Outside Diameter	22.0mm (0.8661")	21.95mm (0.8641")
Bushing Inside Diameter	22.128mm (0.8712")	22.37mm (0.8807")
Pivot Shaft Bend	0	0.2mm (0.008")
<b>S2 AND S3 MODELS</b>		
Pivot Sleeve Outside Diameter	22.0mm (0.8661")	21.95mm (0.8641")
Bushing Inside Diameter	22.030mm (0.8673")	22.30mm (0.8780")
Pivot Shaft Bend	0	0.2mm (0.008")

**TIRE SPECIFICATIONS**

H-SERIES MODELS	
Front Tire Size	3.25 X 19
Rear Tire Size	4.00 X 18
Front Tire Inflation	26 psi*
Rear Tire Inflation	31 psi**
<b>S1 MODELS</b>	
Front Tire Size	3.00 X 18
Rear Tire Size	3.25 X 18
Front Tire Inflation	24 psi
Rear Tire Inflation	31 psi
<b>S2 MODELS</b>	
Front Tire Size	3.00 X 18
Rear Tire Size	3.50 X 18
Front Tire Inflation	24 psi
Rear Tire Inflation	31 psi
<b>S3 MODELS</b>	
Front Tire Size	3.25 X 18
Rear Tire Size	3.50 X 18
Front Tire Inflation	24 psi
Rear Tire Inflation	31 psi

\*29 psi for high speeds  
\*\*34 psi for high speeds

**FORK SPECIFICATIONS**

H1, H1A, H1C	Standard	Service Limit	H2B, H2C	
Spring Length	345mm (13.58")	335mm (13.19")	Spring Length	345mm (13.58") 335mm (13.19")
Oil Type	SAE 10	—	Oil Type	SAE 10
Oil Quantity (per side)	230cc (7.8 fl. oz.)	—	Oil Quantity (per side)	175cc (5.9 fl. oz.)
Oil Level (from top)	380mm (15")	—	Oil Level (from top)	368mm (14.5")
<b>H1B, H1D, H2, H2A</b>			<b>S1A, S1B, S1C, S2</b>	
Spring Length	345mm (13.58")	335mm (13.19")	Spring Length	361mm (14.21") 350mm (13.78")
Oil Type	SAE 10	—	Oil Type	SAE 10
Oil Quantity (per side)	160cc (5.4 fl. oz.)	—	Oil Quantity (per side)	210cc (7.1 fl. oz.)
Oil Level (from top)	448mm (17.63")	—	Oil Level (from top)	375mm (14.78")
<b>H1E, H1F</b>			<b>S2A, S3, S3A</b>	
Spring Length	345mm (13.58")	335mm (13.19")	Spring Length	258.5mm (10.18") 248mm (9.76")
Oil Type	SAE 10	—	Oil Type	SAE 10
Oil Quantity (per side)	170cc (5.7 fl. oz.)	—	Oil Quantity (per side)	155cc (5.24 fl. oz.)
Oil Level (from top)	380mm (15")	—	Oil Level (from top)	355mm (13.98")



## DRUM BRAKE SPECIFICATIONS

H1 MODELS	Standard	Service Limit
Shoe Lining Thickness	5mm (0.2")	3mm (0.12")
Drum Inside Diameter:		
Front	200mm (7.874")	200.75mm (7.904")
Rear	180mm (7.087")	180.75mm (7.116")
Shoe Spring Length:		
Front	60mm (2.36")	63mm (2.48")
Rear	66.5mm (2.62")	69.5mm (2.74")
Camshaft Outside Diameter	14.984mm (0.5899")	14.75mm (0.5807")
Panel Camshaft Hole Inside Diameter	15.027mm (0.5916")	15.25mm (0.6004")
<b>H2 MODELS</b>		
Shoe Lining Thickness	5mm (0.2")	3mm (0.12")
Drum Inside Diameter	200mm (7.874")	200.75mm (7.904")
Shoe Spring Length	66.5mm (2.62")	69.5mm (2.74")
Camshaft Outside Diameter	16.984mm (0.6687")	16.75mm (0.6594")
Panel Camshaft Hole Inside Diameter	17.027mm (0.6704")	17.25mm (0.6791")
<b>S-SERIES MODELS</b>		
Shoe Lining Thickness	5mm (0.2")	2mm (0.08")
Drum Inside Diameter	180mm (7.087")	180.75mm (7.116")
Shoe Spring Length:		
Front	47mm (1.85")	50mm (1.97")
Rear	56mm (2.20")	59mm (2.32")
Camshaft Outside Diameter	14.984mm (0.5899")	14.75mm (0.5807")
Panel Camshaft Hole Inside Diameter	15.0mm (0.5906")	15.25mm (0.6004")

## DISC BRAKE SPECIFICATIONS

ALL MODELS	Standard	Service Limit
Master Cylinder Bore Inside Diameter	14.0-14.043mm (0.5512-0.5529")	14.080mm (0.5543")
Master Cylinder Piston Outside Diameter	13.957-13.984mm (0.5495-0.5506")	13.90mm (0.5472")
Master Cylinder Cups Outside Diameter	14.65-15.15mm (0.5768-0.5965")	14.50mm (0.5709")
Master Cylinder Spring Free Length	51.1mm (2.169")	48.0mm (1.89")
Caliper Bore Inside Diameter	38.18-38.20mm (1.5031-1.5039")	38.215mm (1.5045")
Caliper Piston Outside Diameter	38.115-38.148mm (1.5006-1.5019")	38.105mm (1.5002")
Disc Thickness	7mm (0.276")	5.5mm (0.217")
Disc Runout	0	0.3mm (0.012")

## AXLE TIGHTENING TORQUE SPECIFICATIONS

H-SERIES MODELS	
Front Axle	55 ft-lbs.
Front Axle Clamps	14 ft-lbs.
Rear Axle	100 ft-lbs.
<b>S-SERIES MODELS</b>	
Front Axle	55 ft-lbs.
Front Axle Clamps	14 ft-lbs.
Rear Axle	55 ft-lbs.

## DISC BRAKE TORQUE SPECIFICATIONS

Brake Lever Pivot Bolt	3.5 ft-lbs.
Brake Lever Adjuster	6.0 ft-lbs.
Master Cylinder Clamp Bolt	4.5 ft-lbs.
All Banjo Bolts	20.0 ft-lbs.
All Brake Pipe Fittings	12.0 ft-lbs.
Three-Way Fitting Mounting Bolts	13.0 ft-lbs.
Hydraulic Brake Light Switch	13.0 ft-lbs.
Caliper Shaft	22.0 lb-ft.
Bleeder Valve	6.0 lb-ft.
Disc Mounting Bolts	12.0 lb-ft.